

ICC-ES Evaluation Report

ESR-3702

Reissued July 2023

Revised November 2024

Subject to renewal July 2025

ICC-ES Evaluation Reports are not to be construed as representing aesthetics or any other attributes not specifically addressed, nor are they to be construed as an endorsement of the subject of the report or a recommendation for its use. There is no warranty by ICC Evaluation Service, LLC, express or implied, as to any finding or other matter in this report, or as to any product covered by the report.

Copyright © 2024 ICC Evaluation Service, LLC. All rights reserved.

<p>DIVISION: 09 00 00— FINISHES</p> <p>Section: 09 96 43— Fire-Retardant Coatings</p>	<p>REPORT HOLDER:</p> <p>INTERNATIONAL FIREPROOF TECHNOLOGY INC.</p>	<p>EVALUATION SUBJECT:</p> <p>DC315 INTUMESCENT COATING</p>	
---	--	---	---

1.0 EVALUATION SCOPE

Compliance with the following codes:

- 2024, 2021, 2018, 2015, 2012, 2009 and 2006 [International Building Code® \(IBC\)](#)
- 2024, 2021, 2018, 2015, 2012, 2009 and 2006 [International Residential Code® \(IRC\)](#)

Properties evaluated:

- Application without a prescriptive thermal barrier
- Application without a prescriptive ignition barrier
- Physical properties
- Surface burning characteristics
- Water vapor transmission
- Exterior walls in Types I through IV construction
- Fire-resistance-rated construction

2.0 USES

DC315 is a liquid-applied coating intended for application over the surface of spray-applied foam plastic insulation complying with ICC-ES Acceptance Criteria for Spray-applied Foam Plastic Insulation (AC377). The coating may be used in all types of construction under the IBC and in dwellings under the IRC. The coated assemblies described in Table 1 may be left exposed to the interior of the building without the application of a code-prescribed thermal barrier when installed as described in Section 4.2 of this report. The DC315 coating may be used in attic and crawl spaces as described in Section 4.3 of this report. See Section 4.4 for use in exterior walls of Types I, II, III and IV construction. The DC315 coating may be used in fire-resistance-rated construction when installed in accordance with Section 4.5 of this report.

3.0 DESCRIPTION

3.1 General:

DC315 is a single-component, water-based, liquid-applied intumescent coating and are available in white, ice gray, dark gray and charcoal black. The coating is supplied in 5-gallon (19 L) pails and 55-gallon (208 L) drums and has a shelf life of one (1) year when stored in factory-sealed containers at temperatures between 50° and 80°F (10 and 27°C).

DC315 Primer is a liquid-applied primer, manufactured by International Fireproof Technology, Inc., and is supplied in 1- and 5-gallon (3.8 and 18.9 L) pails, and has a shelf life of 2 years when stored in factory-sealed containers at temperatures between 50° and 80°F (10 and 27°C).

DTM Bonding Primer is a waterborne, acrylic emulsion, bonding primer manufactured by Sherwin-Williams. The primer is supplied in 1- and 5-gallon (3.8 and 18.9 L) containers, and has a shelf life of three (3) years when stored in factory-sealed containers at temperatures between 50° and 100°F (10 and 38°C).

3.2 Vapor Retarder:

When a minimum thickness of 18 mils WFT [0.018 inch (0.46 mm)] of DC315 is applied to a minimum thickness of 2 inches (50.8 mm) of open-cell spray-applied foam plastic insulation, the assembly has a vapor permeance greater than 1 perm (5.7×10^{-11} kg/Pa-s- m^2) and less than 10 perms (5.7×10^{-10} kg/Pa-s- m^2) when tested in accordance with ASTM E96 procedure A (desiccant method), and qualifies as a Class III vapor retarder.

3.3 Surface Burning Characteristics:

When tested in accordance with ASTM E84 or UL 723, at a thickness of 13 mils WFT [0.013 inch (0.33 mm)], DC315 has a flame spread index of 25 or less and a smoke-developed index of 450 or less. The DC315 coated foam assemblies listed in [Table 1](#) were tested in accordance with NFPA 286 and comply with the acceptance criteria of 2024, 2021 and 2018 IBC Section 803.1.1.1 (2015, 2012 and 2009 IBC Section 803.1.2.1 and 2006 IBC Section 803.2.1) and 2024, 2021, 2018, 2015, 2012 and 2009 IRC Section R302.9.4 (2006 IRC Section R315.4) and is permitted to be used where a Class A classification in accordance with ASTM E 84 or UL 723 is required by 2024, 2021 and 2018 IBC Section 803.13 (2015 IBC Section 803.11, 2012 and 2009 IBC Section 803.9 and 2006 IBC Section 803.5).

4.0 DESIGN AND INSTALLATION

4.1 Installation – General:

DC315 must be applied in accordance with the manufacturer's published application instructions and this report. A copy of the instructions must be available on the job site at all times.

DC315 must be mechanically mixed prior to application. The coating is applied to the required thickness using spray equipment, a brush or a roller having a medium nap. Surfaces to be coated must be inspected in accordance with the manufacturer's published installation instructions and must be dry, clean, and free of dirt, loose debris and other substances that could interfere with the adhesion of the coating. The coating must not be applied when the ambient or surface temperature is below 50°F (10°C) or above 90°F (32° C) and relative humidity of more than 85%. The manufacturer must be consulted for specific application conditions.

4.2 Application without a Prescriptive Thermal Barrier:

The DC315 coating may be applied over spray-applied foam plastic insulations listed in [Table 1](#) without covering the coated assembly with the thermal barrier prescribed in IBC Section 2603.4 and 2024 IRC Section R303.4 [2021, 2018, 2015, 2012 and 2009 IRC Section R316.4 (2006 IRC Section R314.4)].

The DTM Bonding Primer, when used as part of the assemblies listed in [Table 1](#), must be installed in accordance with the manufacturer's published installation instructions.

4.3 Application without a Prescriptive Ignition Barrier:

4.3.1 General: Where spray-applied foam plastic insulations listed in [Table 2](#) are installed in attics and crawl spaces without the ignition barrier prescribed in IBC Section 2603.4.1.6 and 2024 IRC Sections R303.5.3 and R303.5.4 [2021, 2018, 2015, 2012 and 2009 IRC Sections R316.5.3 and R316.5.4 (2006 IRC Sections R314.5.3 and R314.5.4)] the installation must be in accordance with Sections 4.3.2 and 4.3.3, and the following conditions apply:

- a. Entry to the attic or crawl space is only to service utilities, and no storage is permitted.
- b. There are no interconnected attic or crawl space areas.
- c. Air in the attic or crawl space is not circulated to other parts of the building.
- d. Attic ventilation is provided when required by 2024, 2021 and 2018 IBC Section 1202.2 (2015, 2012, 2009 and 2006 IBC Section 1203.2) or IRC Section R806, except when air-impermeable insulation is permitted in unvented attics in accordance with the 2024, 2021 and 2018 IBC Section 1202.3 (2015 IBC Section 1203.3) or 2024, 2021, 2018, 2015 and 2012 IRC Section R806.5 (2009 IRC Section R806.4).
- e. Under-floor (crawl space) ventilation is provided when required by 2024, 2021 and 2018 IBC Section 1202.4 [2015 IBC Section 1203.4 (2012, 2009 and 2006 IBC Section 1203.3)] or IRC Section R408.1, as applicable.
- f. Combustion air is provided in accordance with IMC (*International Mechanical Code*®) Section 701.

4.3.2 In attics and crawl spaces: In attics, the insulation may be spray-applied to the underside of roof sheathing or roof rafters, and/or vertical surfaces; and in crawl spaces, the insulation may be spray-applied to the underside of floors and/or vertical surfaces provided the assembly conforms to one of the assemblies described in [Table 2](#).

4.3.3 Use on Attic Floors: The insulation may be installed between and over the joists in attic floor at the maximum thickness set forth in [Table 2](#). The insulation must be separated from the interior of the building by an approved thermal barrier. An ignition barrier prescribed in IBC Section 2603.4.1.6 and 2024 IRC Sections R303.5. and R303.5.4 [2021, 2018, 2015, 2012 and 2009 IRC Sections R316.5.3 and R316.5.4 (2006 IRC Sections R314.5.3 and R314.5.4)] may be omitted.

4.4 Exterior Walls in Types I, II, III and IV Construction: DC315 coating may be installed in or on exterior walls of buildings of Type I, II, III and IV construction as described in [Table 3](#). Evaluation of the spray foam insulation with other applicable requirements of AC377 and IBC Section 2603.5 are outside the scope of this report. The maximum thickness of the foam plastic installed on the exterior of the sheathing or installed in stud cavities must be as described in [Table 3](#).

4.5 Fire-resistance-rated Construction: Non-loadbearing wall assemblies, as described in [Figures 4](#) through [10](#) with DC315 intumescent coating as a component of each assembly, have fire-resistance ratings based on the unexposed surface temperature provisions under 2024 IBC Section 705.8 (2021, 2018, 2015, 2012 and 2009 IBC Section 705.7) and tested in accordance with ASTM E119.

5.0 CONDITIONS OF USE:

The DC315 coating described in this report complies with, or is a suitable alternative to what is specified in, those codes listed in Section 1.0 of this report, subject to the following conditions:

- 5.1** Application must comply with this report, the manufacturer's published installation instructions, and the applicable code. A copy of the installation instructions must be on the job site during application of the coating. In the event of a conflict between the manufacturer's published installation instructions and this report, this report and the code govern.
- 5.2** The application of topcoat paints over the DC315 coating is limited to interior/exterior latex, acrylic and silicone alkyds topcoats applied at an average wet film thickness of 8.0 mils [0.08 inch (0.20 mm)]. Topcoat paints may be applied over the DC315 coating at maximum average wet film thickness of 12 mils [0.012 inch (0.30mm)] when specified in this report. The use of either of the two interior finishes in conjunction with a vapor retardant coating is outside the scope of this report.
- 5.3** Installation in accordance with this report is for the specific assemblies and spray-applied foam plastic insulations described in [Tables 1](#) and [2](#). The spray-applied foam plastic insulation must be installed in accordance with the requirements set forth in the specific ICC-ES evaluation report noted. For spray-applied foam plastic insulation that is not covered in an ICC-ES evaluation report, the evaluation is limited as noted in [Tables 1](#) and [2](#), Footnote 3.
- 5.4** When used in or on the exterior walls of buildings of Type I, II III or IV construction, the wall assembly must conform to those described in Section 4.4, [Table 3](#) and [Figures 1](#) through [3](#).
- 5.5** When used in fire-resistance-rated construction, the wall assembly must conform to those described in Section 4.5 and [Figures 4](#) through [10](#).
- 5.6** Each fire-resistance rated assembly, described in [Figures 4](#) through [10](#), reports respective equivalent opening factors (F_{EO}) derived from 2024 Section 705.8 (2021, 2018, 2015, 2012 and 2009 IBC Figure 705.7) and must be used in the calculation of the equivalent area of protected openings (A_C) to achieve the Assembly Rating. Calculation of A_C is the sole responsibility of the end user and outside of the scope of this listing.
- 5.7** For spray-applied foam plastic insulation listed in [Tables 1](#) through [3](#) or [Figures 4](#) through [10](#) that are not covered in an ICC-ES evaluation report, the spray-applied foam plastic is limited to the test data for the coated assembly described. Evaluation for compliance of the spray foam insulation with other applicable requirements of AC377 and the IBC and IRC are outside the scope of this report and must be approved by the code official.
- 5.8** The coating is manufactured in Taoyuan, Taiwan and Irvine, California, under a quality control program with inspections by ICC-ES.

6.0 EVIDENCE SUBMITTED

- 6.1 Data in accordance with the [ICC-ES Acceptance Criteria for Fire-Protective Coatings Applied to Spray-applied Foam Plastic Insulation Installed without a Code-prescribed Thermal Barrier \(AC456\)](#), dated October 2015 (Editorially revised July 2024).
- 6.2 Reports of room corner fire testing in accordance with NFPA 286 as specified in 2024, 2021, 2018, 2015, 2009, and 2006 IBC Section 2603.9 (2012 IBC Section 2603.10) and 2024 R303.6 IRC [2021, 2018, 2015, 2012, 2009 IRC Section R316.6 (2006 IRC Section R314.6)].
- 6.3 Report of testing in accordance with ASTM E84 (UL 723).
- 6.4 Report of vapor permeance test in accordance with ASTM E96 (Desiccant method).
- 6.5 Report of testing in accordance with Appendix X of AC377.
- 6.6 Report of fire propagation characteristics testing in accordance with NFPA 285 and associated fire engineering analysis supporting the NFPA 285 test report.
- 6.7 Data on accelerated weathering, resistance to humidity and thermal cycling testing in accordance with ASTM D5894, ASTM D4585 and ASTM D3346, respectively.
- 6.8 Report of testing in accordance with ASTM E119 (UL 263) and calculations demonstrating compliance with 2024 IBC Section 705.8 (2021, 2018, 2015, 2012 and 2009 IBC Section 705.7).

7.0 IDENTIFICATION

- 7.1 The ICC-ES mark of conformity, electronic labeling, or the evaluation report number (ICC-ES ESR-3702) along with the name, registered trademark, or registered logo of the report holder (International Fireproof Technology Inc.) must be included in the product label.
- 7.2 In addition, all containers of DC315 coating must be labeled with the manufacturer's address; the product name; the date of manufacture, the shelf life or expiration date and the manufacturer's instructions for application.

The spray-applied foam plastic insulations must be labeled in accordance with the applicable evaluation report (see [Table 1](#)).

- 7.3 The report holder's contact information is the following:

INTERNATIONAL FIREPROOF TECHNOLOGY INC.
17528 VON KARMAN AVENUE
IRVINE, CALIFORNIA 92614
(949) 975-8588
www.painttoprotect.com
ptp@painttoprotect.com

**TABLE 1—USE OF INSULATION WITHOUT A PRESCRIPTIVE THERMAL BARRIER
(TESTED IN ACCORDANCE WITH NFPA 286)**

INSULATION COMPANY NAME	INSULATION PRODUCT NAME	MAXIMUM THICKNESS (in.) (Vertical Surfaces)	MAXIMUM THICKNESS (in.) (Overhead Surfaces)	DC315 COATING MINIMUM AVERAGE THICKNESS ¹ (Applied to all Foam Surfaces)	MINIMUM THEORETICAL APPLICATION RATE OF COATING ²
Acme Urethanes	WC-50 (See Note 3)	8	14	12 mils DFT 18 mils WFT	1.13 gal/100 ft ²
Alpha Polymers LLC	AP 210 HFP (CC) (ESR-5242)	8	12	9 mils DFT 14 mils WFT	0.88 gal/ 100 ft ²
AMBIT Polyurethane LLC	AMBI-SEAL 5.0 (See Note 3)	8	14	12 mils DFT 18 mils WFT	1.13 gal/100 ft ²
AMBIT Polyurethane LLC	AmbiTite 204 (HFO) (ESR-4427)	8	12	9 mils DFT 14 mils WFT	0.88 gal/100 ft ²
AMBIT Polyurethane LLC	AmbiTite 201 245fa (See Note 3)	8	12	9 mils DFT 14 mils WFT	0.88 gal/100 ft ²
AMD Distribution LLC	Diamond Back (See Note 3)	7½	11½	9 mils DFT 14 mils WFT	0.88 gal/100 ft ²
Barnhardt Manufacturing Company dba NCFI Polyurethanes	InsulStar® Light 12-008 (See Note 3)	8	14	9 mils DFT 14 mils WFT	0.88 gal/100 ft ²
Barnhardt Manufacturing Company dba NCFI Polyurethanes	InsulBloc® (ESR-1615)	5½	9½	9 mils DFT 14 mils WFT	0.88 gal/100 ft ²
Barnhardt Manufacturing Company dba NCFI Polyurethanes	InsulStar® (ESR-1615)	5½	9½	9 mils DFT 14 mils WFT	0.88 gal/100 ft ²
Barnhardt Manufacturing Company dba NCFI Polyurethanes	InsulBloc® (ESR-1615)	8¼	10¼	12 mils DFT 18 mils WFT	1.13 gal/100 ft ²
Barnhardt Manufacturing Company dba NCFI Polyurethanes	InsulStar® (ESR-1615)	8¼	10¼	12 mils DFT 18 mils WFT	1.13 gal/100 ft ²
Barnhardt Manufacturing Company dba NCFI Polyurethanes	InsulStar® 1.7 SmartSPF™ (See Note 3)	5½	9½	9 mils DFT 14 mils WFT	0.88 gal/100 ft ²
Barnhardt Manufacturing Company dba NCFI Polyurethanes	InsulBloc® 1.7 SmartSPF™ (See Note 3)	5½	9½	9 mils DFT 14 mils WFT	0.88 gal/100 ft ²
Barnhardt Manufacturing Company dba NCFI Polyurethanes	Sealtite OCX (See Note 3)	10	14	12 mils DFT 18 mils WFT	1.13 gal/100 ft ²
Barnhardt Manufacturing Company dba NCFI Polyurethanes	InsulStar®SmartSPF™ (See Note 3)	6	10	9 mils DFT 14 mils WFT	0.88 gal/100 ft ²
Barnhardt Manufacturing Company dba NCFI Polyurethanes	InsulBloc®SmartSPF™ (See Note 3)	6	10	9 mils DFT 14 mils WFT	0.88 gal/100 ft ²
Barnhardt Manufacturing Company dba NCFI Polyurethanes	NCFI 23-026 (See Note 3)	6	6	12 mils DFT 18 mils WFT	1.13 gal/100 ft ²
BASF Corporation	ENERTITE® G (ESR-3102)	8½	14	9 mils DFT 14 mils WFT	0.88 gal/100 ft ²
BASF Corporation	WALLTITE® LWP (ESR-2642)	5½	11½	14 mils DFT 20 mils WFT	1.25 gal/100 ft ²
BPI Synergy Chemical, LLC	Pureseal 2.0 Closed Cell (ESR-5170)	4	4	10 mils DFT 15 mils WFT	0.94 gal/100 ft ²
Carlisle Spray Foam Insulation	Foamsulate 50 ES (See Note 3)	8½	14	9 mils DFT 14 mils WFT	0.88 gal/100 ft ²
Carlisle Spray Foam Insulation	Foamsulate 50 HY (See Note 3)	8½	14	9 mils DFT 14 mils WFT	0.88 gal/100 ft ²
Carlisle Spray Foam Insulation	Foamsulate 70 (See Note 3)	8½	14	9 mils DFT 14 mils WFT	0.88 gal/100 ft ²
Carlisle Spray Foam Insulation	Foamsulate Closed Cell (See Note 3)	5½	9½	9 mils DFT 14 mils WFT	0.88 gal/100 ft ²
Carlisle Spray Foam Insulation	Foamsulate HFO (See Note 3)	5½	9½	9 mils DFT 14 mils WFT	0.88 gal/100 ft ²
Carlisle Spray Foam Insulation	Foamsulate OCX (See Note 3)	9	14	9 mils DFT 14 mils WFT	0.88 gal/100 ft ²

**TABLE 1—USE OF INSULATION WITHOUT A PRESCRIPTIVE THERMAL BARRIER
(TESTED IN ACCORDANCE WITH NFPA 286) (Continued)**

INSULATION COMPANY NAME	INSULATION PRODUCT NAME	MAXIMUM THICKNESS (in.) (Vertical Surfaces)	MAXIMUM THICKNESS (in.) (Overhead Surfaces)	DC315 COATING MINIMUM AVERAGE THICKNESS ¹ (Applied to all Foam Surfaces)	MINIMUM THEORETICAL APPLICATION RATE OF COATING ²
Carlisle Spray Foam Insulation	SealTite PRO Closed Cell (See Note 3)	5½	9½	9 mils DFT 14 mils WFT	0.88 gal/100 ft ²
Carlisle Spray Foam Insulation	SealTite PRO High Yield (See Note 3)	8½	14	9 mils DFT 14 mils WFT	0.88 gal/100 ft ²
Carlisle Spray Foam Insulation	SealTite PRO Open Cell XTR (See Note 3)	8½	14	9 mils DFT 14 mils WFT	0.88 gal/100 ft ²
Carlisle Spray Foam Insulation	SealTite PRO No Trim 21 (See Note 3)	8½	14	9 mils DFT 14 mils WFT	0.88 gal/100 ft ²
Carlisle Spray Foam Insulation	SealTite PRO OCX (See Note 3)	9	14	9 mils DFT 14 mils WFT	0.88 gal/100 ft ²
Carlisle Spray Foam Insulation	SealTite PRO One Zero Closed Cell (See Note 3)	5½	9½	9 mils DFT 14 mils WFT	0.88 gal/100 ft ²
Carlisle Spray Foam Insulation	SealTite PRO Open Cell (See Note 3)	8½	14	9 mils DFT 14 mils WFT	0.88 gal/100 ft ²
Carlisle Spray Foam Insulation	SealTite™ PRO HFO (See Note 3)	7½	11½	9 mils DFT 14 mils WFT	0.88 gal/100 ft ²
Commercial Thermal Solutions, Inc.	Tiger Foam® E-84 Fire-Rated SPF Class 1 Spray Foam System (ESR-3183)	2	2	13 mils DFT 20 mils WFT	1.25 gal/100 ft ²
Creative Polymer Solutions	Accufoam CC (ESR-5255)	5½	9½	13 mils DFT 19 mils WFT	1.19 gal/100 ft ²
Creative Polymer Solutions	Accufoam OC (ESR-5254)	8	14	12 mils DFT 18 mils WFT	1.13 gal/100 ft ²
Creative Polymer Solutions	Accufoam OC (ESR-5254)	10	12	12 mils DFT 18 mils WFT	1.1 gal/100 ft ²
Creative Polymer Solutions	Accufoam 2.0 Regular HFO (See Note 3)	7½	9½	9 mils DFT 14 mils WFT	0.88 gal/100 ft ²
Creative Polymer Solutions	AccuFoam AF1 (ESR-5255)	10	12	12 mils DFT 18 mils WFT	1.1 gal/100 ft ²
Creative Polymer Solutions	AccuFoam AF1 (ESR-5255)	8	14	12 mils DFT 18 mils WFT	1.13 gal/100 ft ²
Creative Polymer Solutions	AirLok 45 (ESR-5253)	8	14	12 mils DFT 18 mils WFT	1.13 gal/100 ft ²
Creative Polymer Solutions	AirLok 45 (ESR-5253)	10	12	12 mils DFT 18 mils WFT	1.1 gal/100 ft ²
Creative Polymer Solutions	AirLok 170 (ESR-5253)	5½	9½	13 mils DFT 19 mils WFT	1.2 gal/100 ft ²
DAP Global, Inc.	Touch N' Foam Professional Class I FR Spray Foam System (ESR-3052)	3½	3½	13 mils DFT 20 mils WFT	1.25 gal/100 ft ²
DAP Global, Inc.	Touch N' Seal Class I FR Spray Foam System (ESR-3052)	3½	3½	13 mils DFT 20 mils WFT	1.25 gal/100 ft ²
DAP Global, Inc.	Touch N' Seal Class I FR Spray Foam System (LOW GWP) (ESR-3052)	¾	¾	12 mils DFT 18 mils WFT	1.13 gal/100 ft ²
DAP Global, Inc.	Touch N' Foam Professional Class I FR Spray Foam System (LOW GWP) (ESR-3052)	¾	¾	12 mils DFT 18 mils WFT	1.13 gal/100 ft ²

**TABLE 1—USE OF INSULATION WITHOUT A PRESCRIPTIVE THERMAL BARRIER
(TESTED IN ACCORDANCE WITH NFPA 286) (Continued)**

INSULATION COMPANY NAME	INSULATION PRODUCT NAME	MAXIMUM THICKNESS (in.) (Vertical Surfaces)	MAXIMUM THICKNESS (in.) (Overhead Surfaces)	DC315 COATING MINIMUM AVERAGE THICKNESS ¹ (Applied to all Foam Surfaces)	MINIMUM THEORETICAL APPLICATION RATE OF COATING ²
DAP Global, Inc.	Touch N' Seal Class I FR Spray Foam System (ESR-3052)	2	2	13 mils DFT 20 mils WFT	1.25 gal/ 100 ft ²
DAP Global, Inc.	Touch N' Foam Professional Class I FR Spray Foam System (ESR-3052)	2	2	13 mils DFT 20 mils WFT	1.25 gal/ 100 ft ²
DAP Global, Inc.	Touch N' Seal HVAC 1.75 Spray Foam System (ESR-5042)	2	2	13 mils DFT 20 mils WFT	1.25 gal/ 100 ft ²
DAP Global, Inc.	Touch N' Seal HVAC 1.75 Spray Foam System (LOW GWP) (ESR-5042)	3 ¹ / ₄	3 ¹ / ₄	12 mils DFT 18 mils WFT	1.13 gal/ 100 ft ²
DuPont de Nemours, Inc.	FROTH-PAK™ (ESR-3228)	3 ¹ / ₂	3 ¹ / ₂	14 mils DFT 20 mils WFT	1.25 gal/100 ft ²
Dynamo Polyurethanes	Dynamo ECO2000 (See Note 3)	10	14	8 mils DFT 14 mils WFT	0.88 gal/100 ft ²
Dynamo Polyurethanes.	Dynamo 500 No Mix OC (See Note 3)	7 ¹ / ₄	7 ¹ / ₄	12 mils DFT 18 mils WFT	1.13 gal/100 ft ²
Elastochem Specialty Chemicals, Inc.	Elastochem® Insulthane® Extreme (See Note 3)	7 ¹ / ₄	7 ¹ / ₄	12 mils DFT 18 mils WFT	1.13 gal/100 ft ²
Elastochem Specialty Chemicals, Inc.	Insulthane 200 Evolution (See Note 3)	5 ¹ / ₂	9 ¹ / ₂	9 mils DFT 14 mils WFT	0.88 gal/100 ft ²
Elastochem Specialty Chemicals, Inc.	Insulthane® 450 NM (See Note 3)	10	14	8 mils DFT 14 mils WFT	0.88 gal/100 ft ²
Elastochem Specialty Chemicals, Inc.	Elastochem 500 (See Note 3)	8	12	13.7 mils DFT 20.5 mils WFT	1.28 gal /100 ft ²
Elastochem Specialty Chemicals, Inc.	Elastochem® Insulthane® Extreme HL (See Note 3)	7 ¹ / ₄	7 ¹ / ₄	12 mils DFT 18 mils WFT	1.13 gal/100 ft ²
Elastochem Specialty Chemicals, Inc.	Elastochem 500 LE (See Note 3)	8	12	13.7 mils DFT 20.5 mils WFT	1.28 gal /100 ft ²
Elastochem Specialty Chemicals, Inc.	Elastochem 500 HY (See Note 3)	8	12	13.7 mils DFT 20.5 mils WFT	1.28 gal /100 ft ²
EnergyOne America	EOA 2000 (See Note 3)	5 ¹ / ₂	9 ¹ / ₂	9 mils DFT 14 mils WFT	0.88 gal/100 ft ²
EnergyOne America	EOA 500 (See Note 3)	8 ¹ / ₂	14	9 mils DFT 14 mils WFT	0.88 gal/100 ft ²
Enerlab - USA	Ecothane 500 (See Note 3)	8	14	9 mils DFT 14 mils WFT	0.88 gal/100 ft ²
Enerlab - USA	Ecothane 2.0 (See Note 3)	5 ¹ / ₂	9 ¹ / ₂	9 mils DFT 14 mils WFT	0.88 gal/100 ft ²
Enerlab- USA	Ecothane 2.0 (See Note 3)	8 ¹ / ₄	10 ¹ / ₄	12 mils DFT 18 mils WFT	1.13 gal/100 ft ²
Enerlab - USA	Ecothane 2.0 (See Note 3)	6	10	9 mils DFT 14 mils WFT	0.88 gal/100 ft ²
Foam Suppliers	EcoStar CC (See Note 3)	8	12	12 mils DFT 18 mils WFT	1.13 gal/100 ft ²
Foam Suppliers	Genfoam OC (See Note 3)	8 ¹ / ₂	14	12 mils DFT 18 mils WFT	1.13 gal/100 ft ²
Foam Suppliers	GenX (See Note 3)	7 ¹ / ₂	11 ¹ / ₂	13 mils DFT 20 mils WFT	1.25 gal/100 ft ²
Franklin International, Inc.	Titebond Weathermaster Superfoam (See Note 3)	2	2	13 mils DFT 20 mils WFT	1.25 gal/100 ft ²
General Coatings Manufacturing Corp.	Ultrathane 050 (See Note 3)	8	10	13 mils DFT 20 mils WFT	1.25 gal/100 ft ²

**TABLE 1—USE OF INSULATION WITHOUT A PRESCRIPTIVE THERMAL BARRIER
(TESTED IN ACCORDANCE WITH NFPA 286) (Continued)**

INSULATION COMPANY NAME	INSULATION PRODUCT NAME	MAXIMUM THICKNESS (in.) (Vertical Surfaces)	MAXIMUM THICKNESS (in.) (Overhead Surfaces)	DC315 COATING MINIMUM AVERAGE THICKNESS ¹ (Applied to all Foam Surfaces)	MINIMUM THEORETICAL APPLICATION RATE OF COATING ²
General Coatings Manufacturing Corp.	Ultra-Thane 230 (See Note 3)	5½	7½	DTM Bonding Primer 3 mils DFT/ 4 mils WFT & DC315 12 mils DFT/ 18 mils WFT	0.25 gal/100 ft ² & 1.13 gal/100 ft ²
General Coatings Manufacturing Corp.	Ultrathane 202 (See Note 3)	8	12	12 mils DFT 18 mils WFT	1.13 gal/100 ft ²
General Coatings Manufacturing Corp.	UPC 2.0 (See Note 3)	8	12	12 mils DFT 18 mils WFT	1.13 gal/100 ft ²
General Coatings Manufacturing Corp.	Ultrathane 050 Max (See Note 3)	8	14	14 mils DFT 21 mils WFT	1.31 gal/100 ft ²
General Coatings Manufacturing Corp.	Ultrathane 170 (See Note 3)	8	12	11 mils DFT 16 mils WFT	1.00 gal/100 ft ²
General Coatings Manufacturing Corp.	Ultrathane 205 HFO (See Note 3)	8	12	11 mils DFT 16 mils WFT	1.00 gal/100 ft ²
General Coatings Manufacturing Corp.	Ultrathane 202 MAX (See Note 3)	8	12	11 mils DFT 16 mils WFT	1.00 gal/100 ft ²
General Coatings Manufacturing Corp.	UPC 2.0 MAX (See Note 3)	8	12	11 mils DFT 16 mils WFT	1.00 gal/100 ft ²
Green Valley Products, LLC	GVP500NM (See Note 3)	10	14	8 mils DFT 14 mils WFT	0.88 gal/100 ft ²
Green Valley Products LLC	GVP 2.0 HFO (See Note 3)	7	10	8 mils DFT 14 mils WFT	0.88 gal/100 ft ²
Genyk	Elite 2.0 (ESR-5150)	5½	9½	15 mils DFT 23 mils WFT	1.44 gal/100 ft ²
Guardian Energy Technologies	Foam It Green (See Note 3)	3½	3½	13 mils DFT 20 mils WFT	1.25 gal/100 ft ²
Henry Company	Permax 1.8 (See Note 3)	11¼	11¼	14 mils DFT 21 mils WFT	1.31 gal/100 ft ²
Henry Company	Permax 2.0X (See Note 3)	5½	9½	9 mils DFT 14 mils WFT	0.88 gal/100 ft ²
Henry Company	Permax 2.0X Fast (See Note 3)	5½	9½	9 mils DFT 14 mils WFT	0.88 gal/100 ft ²
Holcim Solutions and Products US, LLC, Building Envelope Division	Enverge Nexseal 2.0 (See Note 3)	5½	9½	9 mils DFT 14 mils WFT	0.88 gal/100 ft ²
Holcim Solutions and Products US, LLC, Building Envelope Division	Enverge Nexseal 2.0 LE (See Note 3)	5½	9½	9 mils DFT 14 mils WFT	0.88 gal/100 ft ²
Holcim Solutions and Products US, LLC, Building Envelope Division	Enverge Easysel 0.5 lb (See Note 3)	8½	14	9 mils DFT 14 mils WFT	0.88 gal/100 ft ²
Holcim Solutions and Products US, LLC, Building Envelope Division	Enverge Sucraseal™ 0.5 (See Note 3)	9	14	9 mils DFT 14 mils WFT	0.88 gal/100 ft ²
Holcim Solutions and Products US, LLC, Building Envelope Division	Enverge OnePass HFO (R1860) N (See Note 3)	5½	9½	9 mils DFT 14 mils WFT	0.88 gal/100 ft ²
Holcim Solutions and Products US, LLC, Building Envelope Division	Everge 183M (See Note 3)	5½	9½	9 mils DFT 14 mils WFT	0.88 gal/100 ft ²
Holcim Solutions and Products US, LLC, Building Envelope Division	Everge OnePass (1880) (See Note 3)	9	12	9 mils DFT 14 mils WFT	0.88 gal/100 ft ²
Holcim Solutions and Products US, LLC, Building Envelope Division	Gaco Firestop2™ F5001 (See Note 3)	18	18	12 mils DFT 18 mils WFT	1.13 gal/100 ft ²
Holcim Solutions and Products US, LLC, Building Envelope Division	Gaco Green 052N (See Note 3)	11¼	11¼	9 mils DFT 14 mils WFT	0.88 gal/100 ft ²
Holcim Solutions and Products US, LLC, Building Envelope Division	GacoEZSpray F4500 (See Note 3)	8½	14	9 mils DFT 14 mils WFT	0.88 gal/100 ft ²
Huntsman Building Solutions	Agribalance® (ESR-2600)	7½	11½	12 mils DFT 18 mils WFT	1.13 gal/100 ft ²

TABLE 1—USE OF INSULATION WITHOUT A PRESCRIPTIVE THERMAL BARRIER
(TESTED IN ACCORDANCE WITH NFPA 286) (Continued)

INSULATION COMPANY NAME	INSULATION COMPANY NAME	INSULATION COMPANY NAME	INSULATION COMPANY NAME	INSULATION COMPANY NAME	INSULATION COMPANY NAME
Huntsman Building Solutions	Heatlok® HFO (ESR-4073)	7½	11½	9 mils DFT 14 mils WFT	0.88 gal/100 ft²
Huntsman Building Solutions	Heatlok® XT-s (ESR-3824)	7½	11½	9 mils DFT 14 mils WFT	0.88 gal/100 ft²
Huntsman Building Solutions	Heatlok® XT-w (ESR-3883)	7½	11½	12 mils DFT 18 mils WFT	1.13 gal/100 ft²
Huntsman Building Solutions	SEALECTION® 500 (ESR-1172)	7½	11½	12 mils DFT 18 mils WFT	1.13 gal/100 ft²
Huntsman Building Solutions	Heatlok HFO Pro (See Note 3)	8	11½	12 mils DFT 18 mils WFT	1.13 gal/100 ft²
Huntsman Building Solutions	Sealection® NM (ESR-2668)	7½	11½	12 mils DFT 18 mils WFT	1.13 gal/100 ft²
Huntsman Building Solutions	Sealection® NM (ESR-2668)	9¼	11¼	12 mils DFT 18 mils WFT	1.13 gal/100 ft²
Huntsman Building Solutions	LD C 50 No Mix (See Note 3)	8½	14	9 mils DFT 14 mils WFT	0.88 gal/100 ft²
Huntsman Building Solutions	Classic (ESR-1826)	8½	14	9 mils DFT 14 mils WFT	0.88 gal/100 ft²
Huntsman Building Solutions	Classic Ultra (ESR-1826)	8½	14	9 mils DFT 14 mils WFT	0.88 gal/100 ft²
Huntsman Building Solutions	Classic Ultra Select (ESR-1826)	8½	14	9 mils DFT 14 mils WFT	0.88 gal/100 ft²
Huntsman Building Solutions	Classic Plus (ESR-1826)	8½	14	9 mils DFT 14 mils WFT	0.88 gal/100 ft²
Huntsman Building Solutions	ProSeal HFO (See Note 3)	5½	9½	9 mils DFT 14 mils WFT	0.88 gal/100 ft²
Huntsman Building Solutions	ProSeal Max HFC (See Note 3)	6	9½	9 mils DFT 14 mils WFT	0.88 gal/100 ft²
Huntsman Building Solutions	Foam-Lok FL 450 (ESR-4242)	8½	14	9 mils DFT 14 mils WFT	0.88 gal/100 ft²
Huntsman Building Solutions	Foam-Lok FL 450 (ESR-4242)	6	14	12 mils DFT 20 mils WFT	1.25 gal/100 ft²
Huntsman Building Solutions	Prime Gold (See Note 3)	8½	14	9 mils DFT 14 mils WFT	0.88 gal/100 ft²
Huntsman Building Solutions	Foam-Lok FL2000 (ESR-2629)	5½	9½	9 mils DFT 14 mils WFT	0.88 gal/100 ft²
Huntsman Building Solutions	Foam-Lok FL2000 (ESR-2629)	6¼	8¼	14 mils DFT 22 mils WFT	1.38 gal/100 ft²
Huntsman Building Solutions	AirTight CC (ESR-2629)	6¼	8¼	14 mils DFT 22 mils WFT	1.38 gal/100 ft²
Huntsman Building Solutions	GuardFoam 55 CC (ESR-2629)	6¼	8¼	14 mils DFT 22 mils WFT	1.38 gal/100 ft²
Huntsman Building Solutions	Foam-Lok AB2000 (ESR-2629)	6¼	8¼	14 mils DFT 22 mils WFT	1.38 gal/100 ft²
Huntsman Building Solutions	Foam-Lok FL500 (ESR-2847)	8½	14	9 mils DFT 14 mils WFT	0.88 gal/100 ft²
Huntsman Building Solutions	Foam-Lok FL500 (ESR-2847)	5¼	11¼	13 mils DFT 20 mils WFT	1.25 gal/100 ft²
Huntsman Building Solutions	AirTight OC (ESR-2847)	5¼	11¼	13 mils DFT 20 mils WFT	1.25 gal/100 ft²
Huntsman Building Solutions	GUARDFOAM 55 OC (ESR-2847)	5¼	11¼	13 mils DFT 20 mils WFT	1.25 gal/100 ft²
Huntsman Building Solutions	Open Cell Retrofit Foam (ESR-2847)	5¼	11¼	13 mils DFT 20 mils WFT	1.25 gal/100 ft²
Huntsman Building Solutions	Lapolla FL 2000 4G (See Note 3)	5½	9½	9 mils DFT 14 mils WFT	0.88 gal/100 ft²
Huntsman Building Solutions	Foam-Lok FL 750 (ESR-4322)	8½	14	9 mils DFT 14 mils WFT	0.88 gal/100 ft²
Huntsman Building Solutions	Foam-Lok FL 750 (ESR-4322)	6½	11½	13 mils DFT 20 mils WFT	1.25 gal/100 ft²
Huntsman Building Solutions	Foam-Lok FL2000-3G (ESR-4501)	5½	9½	9 mils DFT 14 mils WFT	0.88 gal/100 ft²
Huntsman Building Solutions	Foam-Lok FL2000-3G (ESR-4501)	8	14	16 mils DFT 24 mils WFT	1.50 gal/100 ft²
Huntsman Building Solutions	ProSeal (ESR-3500)	5½	9½	16 mils DFT 24 mils WFT	1.50 gal/100 ft²
Huntsman Building Solutions	ProSeal LE (ESR-3500)	5½	9½	16 mils DFT 24 mils WFT	1.50 gal/100 ft²

TABLE 1—USE OF INSULATION WITHOUT A PRESCRIPTIVE THERMAL BARRIER
(TESTED IN ACCORDANCE WITH NFPA 286) (Continued)

INSULATION COMPANY NAME	INSULATION COMPANY NAME	INSULATION COMPANY NAME	INSULATION COMPANY NAME	INSULATION COMPANY NAME	INSULATION COMPANY NAME
Huntsman Building Solutions	Icynene Classic 45 (ESR-5498)	8½	14	9 mils DFT 14 mils WFT	0.88 gal/100 ft²
Huntsman Building Solutions	Icynene OC No-Mix (ESR-5499)	5¼	11¼	13 mils DFT 20 mils WFT	1.25 gal/ 100 ft²
Huntsman Building Solutions	Icynene Ultra 50 (ESR-5497)	7½	11½	12 mils DFT 18 mils WFT	1.13 gal/ 100 ft²
Huntsman Building Solutions	Icynene Classic 75 (ESR-5495)	8½	14	9 mils DFT 14 mils WFT	0.88 gal/ 100 ft²
Huntsman Building Solutions	Icynene High-R 80 (ESR-5494)	7½	11½	12 mils DFT 18 mils WFT	1.13 gal/ 100 ft²
Huntsman Building Solutions	Icynene Xpress 55 (ESR-5432)	8	12	20 mils DFT 30 mils WFT	1.88 gal/ 100 ft²
Huntsman Building Solutions	Icynene HFO MAX (ESR-5496)	7½	11½	12 mils DFT 18 mils WFT	1.13 gal/ 100 ft²
Huntsman Building Solutions	Icynene HFO 200 (See Note 3)	7½	11½	12 mils DFT 18 mils WFT	1.13 gal/ 100 ft²
ICP Construction Inc. dba ICP Building Solutions Group	HandiFoam E-84 Class 1(A) (ESR-2717)	3½	3½	13 mils DFT 20 mils WFT	1.25 gal/100 ft²
ICP Construction Inc. dba ICP Building Solutions Group	HandiFoam E-84 Class 1(A) Spray Foam System (ESR-2717)	2	2	13 mils DFT 20 mils WFT	1.25 gal/100 ft²
ICP Construction Inc. dba ICP Building Solutions Group	HandiFoam E84 HFO (ESR-2717)	4	4	12 mils DFT 18 mils WFT	1.13 gal/100 ft²
ICP Construction Inc. dba ICP Building Solutions Group	HandiFoam E84 HFO (ESR-2717)	3	3	12 mils DFT 18 mils WFT	1.13 gal/100 ft²
ICP Construction Inc., dba ICP Building Solutions Group	HandiFoam HVLP MD 2.0 (See Note 3)	5½	11½	DC315 Prime Coat 3 mils DFT / 4 mils WFT & DC315 11 mils DFT / 16 mils WFT	0.25 gal/100 ft² & 1.00 gal/100 ft²
ICP Construction Inc., dba ICP Building Solutions Group	HandiFoam HVPL HFO 2.0 (See Note 3)	5½	7½	13 mils DFT 20 mils WFT	1.25 gal/100 ft²
Innovative Polymer Systems	IPS 500EZ (See Note 3)	10	14	8 mils DFT 14 mils WFT	0.88 gal/100 ft²
Innovative Polymer Systems	IPS 2000HFO (See Note 3)	7¼	7¼	12 mils DFT 18 mils WFT	1.13 gal/100 ft²
Innovative Polymer Systems	IPS 500Max (See Note 3)	8	12	13.7 mils DFT 20.5 mils WFT	1.28 gal /100 ft²
Johns Manville	JM Corbond III (See Note 3)	5½	9½	9 mils DFT 14 mils WFT	0.88 gal/100 ft²
Johns Manville	JM Corbond MCS™ (See Note 3)	7¼	9¼	14 mils DFT 22 mils WFT	1.38 gal/100 ft²
Johns Manville	JM Corbond oc (See Note 3)	7½	11½	12 mils DFT 18 mils WFT	1.13 gal/100 ft²
Johns Manville	JM Corbond ocx SPF (See Note 3)	9	14	9 mils DFT 14 mils WFT	0.88 gal/100 ft²
Johns Manville	JM MCS+ (See Note 3)	5½	9½	9 mils DFT 14 mils WFT	0.88 gal/100 ft²
Johns Manville	JM Gen IV (See Note 3)	5½	9½	9 mils DFT 14 mils WFT	0.88 gal/100 ft²
Natural Polymers, LLC	Natural-Therm™ 0.5 IB (See Note 3)	9½	14½	9 mils DFT 14 mils WFT	0.88 gal/100 ft²
Natural Polymers, LLC	Natural-Therm™ 0.50 PCF (See Note 3)	9½	14½	9 mils DFT 14 mils WFT	0.88 gal/100 ft²
Natural Polymers, LLC	Natural-Therm™ 2.0 IBS (See Note 3)	5½	9½	9 mils DFT 14 mils WFT	0.88 gal/100 ft²
Natural Polymers, LLC	Natural-Therm™ 2.0 IBW (See Note 3)	5½	9½	9 mils DFT 14 mils WFT	0.88 gal/100 ft²

**TABLE 1—USE OF INSULATION WITHOUT A PRESCRIPTIVE THERMAL BARRIER
(TESTED IN ACCORDANCE WITH NFPA 286) (Continued)**

INSULATION COMPANY NAME	INSULATION COMPANY NAME	INSULATION COMPANY NAME	INSULATION COMPANY NAME	INSULATION COMPANY NAME	INSULATION COMPANY NAME
Natural Polymers, LLC	Natural-Therm™ Light (See Note 3)	9½	14½	9 mils DFT 14 mils WFT	0.88 gal/100 ft²
Natural Polymers, LLC	Natural-Therm™ ZERO (See Note 3)	5½	9½	9 mils DFT 14 mils WFT	0.88 gal/100 ft²
Natural Polymers, LLC	Natural-Therm® 2.0 HFO IBW IBS (See Note 3)	7½	11½	12 mils DFT 18 mils WFT	1.13 gal/100 ft²
Natural Polymers, LLC	Ultra Pure LD (See Note 3)	9½	14½	9 mils DFT 14 mils WFT	0.88 gal/100 ft²
Natural Polymers, LLC	Ultra Pure HD (See Note 3)	7½	11½	12 mils DFT 18 mils WFT	1.13 gal/100 ft²
North American Spray Foam Polymers	EcoPolySeal (See Note 3)	7½	11½	12 mils DFT 18 mils WFT	1.13 gal/100 ft²
North American Spray Foam Polymers	EPS 2000 (See Note 3)	7½	11½	12 mils DFT 18 mils WFT	1.13 gal/100 ft²
Nu-Wool Company Incorporated	Nu-Seal 0.5 (See Note 3)	9½	14½	9 mils DFT 14 mils WFT	0.88 gal/100 ft²
Nu-Wool Company Incorporated	Nu-Seal 2.0 HFO (See Note 3)	8	12	11 mils DFT 16 mils WFT	1.00 gal/100 ft²
Nu-Wool Company Incorporated	Nu-Seal 2.0 (See Note 3)	5½	14	9 mils DFT 14 mils WFT	0.88 gal/100 ft²
PCC Prodex Sp. z.o.o.	Crossin 450 (See Note 3)	8	14	12 mils DFT 18 mils WFT	1.13 gal/100 ft²
Polygreen Solutions	GreenSeal 44 (See Note 3)	8	14	12 mils DFT 18 mils WFT	1.13 gal/100 ft²
Preferred Solutions, Inc.	Staycell® 302 (See Note 3)	5½	9½	9 mils DFT 14 mils WFT	0.88 gal/100 ft²
ProFoam Corporation	ProSeal™ (ESR-3835)	5½	9½	9 mils DFT 14 mils WFT	0.88 gal/100 ft²
ProFoam Corporation	ProSeal™ (ESR-3835)	8¼	10¼	12 mils DFT 18 mils WFT	1.13 gal/100 ft²
ProFoam Corporation	ProSeal™ (ESR-3835)	6	10	9 mils DFT 14 mils WFT	0.88 gal/100 ft²
ProFoam Corporation	ProSeal Plus 1.7 (See Note 3)	5½	9½	9 mils DFT 14 mils WFT	0.88 gal/100 ft²
ProFoam Corporation	ProFill Plus (See Note 3)	8½	14	9 mils DFT 14 mils WFT	0.88 gal/100 ft²
Purinova Sp. z.o.o.	Purinova PURIOS 500 (See Note 3)	8	14	12 mils DFT 18 mils WFT	1.13 gal/100 ft²
Quadrant Performance Materials	EnviroSeal OCX Platinum (See Note 3)	8½	13½	12 mils DFT 18 mils WFT	1.13 gal/100 ft²
Quadrant Performance Materials	EnviroSeal HY (High Yield) (See Note 3)	8	12	13 mils DFT 20 mils WFT	1.25 gal/100 ft²
Quadrant Performance Materials	EnviroSeal CC Platinum Max (See Note 3)	5½	9½	9 mils DFT 14 mils WFT	0.88 gal/100 ft²
Quadrant Performance Materials	EnviroSeal OC Platinum (See Note 3)	10	16	8 mils DFT 14 mils WFT	0.88 gal/100 ft²
RHH Foam Systems	Versi-Foam Class I (See Note 3)	3½	3½	13 mils DFT 20 mils WFT	1.25 gal/100 ft²
Rhino Linings Corporation	ThermalGuard CC2 (ESR-2100)	5½	9½	9 mils DFT 14 mils WFT	0.88 gal/100 ft²
Rhino Linings Corporation	ThermalGuard OC.5 (ESR-2100)	7½	11½	13 mils DFT 18 mils WFT	1.13 gal/100 ft²
Rhino Linings Corporation	Thermal Guard OC 1.0 (ESR-4209)	8½	14	9 mils DFT 14 mils WFT	0.88 gal/100 ft²
SFM Foam	OC NM Pro (See Note 3)	10	14	8 mils DFT 14 mils WFT	0.88 gal/100 ft²
SFM Foam	OC Pro (See Note 3)	8	12	13.7 mils DFT 20.5 mils WFT	1.28 gal /100 ft²
SFM Foam	CC Pro (See Note 3)	5½	9½	9 mils DFT 14 mils WFT	0.88 gal/100 ft²
SFM Foam	CC HFO Pro (See Note 3)	7¼	7¼	12 mils DFT 18 mils WFT	1.13 gal/100 ft²

**TABLE 1—USE OF INSULATION WITHOUT A PRESCRIPTIVE THERMAL BARRIER
(TESTED IN ACCORDANCE WITH NFPA 286) (Continued)**

INSULATION COMPANY NAME	INSULATION COMPANY NAME	INSULATION COMPANY NAME	INSULATION COMPANY NAME	INSULATION COMPANY NAME	INSULATION COMPANY NAME
Soprema	SupraSeal (See Note 3)	7 ¹ / ₄	7 ¹ / ₄	12 mils DFT 18 mils WFT	1.13 gal/100 ft ²
Soudal Accumetric	Soudafoam MAXTWO HFO E84 (ESR-4728)	2	2	12 mils DFT 18 mils WFT	1.13 gal/100 ft ²
Soudal Accumetric	Soudafoam MAXTWO HFO XL E84 (ESR-4728)	2	2	12 mils DFT 18 mils WFT	1.13 gal/100 ft ²
Specialty Products, Inc. (S.P.I.)	Envelo-Seal™ 0.5 OC (See Note 3)	9 ¹ / ₂	14 ¹ / ₂	9 mils DFT 14 mils WFT	0.88 gal/100 ft ²
Specialty Products, Inc. (S.P.I.)	Envelo-Seal™ 2.0 IBW (See Note 3)	5 ¹ / ₂	14	9 mils DFT 14 mils WFT	0.88 gal/100 ft ²
Spray Foam Genie	SFG 0.5 OC (See Note 3)	8	14	9 mils DFT 14 mils WFT	0.88 gal/100 ft ²
Spray Foam Genie	SFG 2.0 CC (See Note 3)	5 ¹ / ₂	9 ¹ / ₂	9 mils DFT 14 mils WFT	0.88 gal/100 ft ²
Spray Foam Genie	SFG 2.0 CC (See Note 3)	8 ¹ / ₄	10 ¹ / ₄	12 mils DFT 18 mils WFT	1.13 gal/100 ft ²
Spray Foam Genie	SFG 2.0 CC (See Note 3)	6	10	9 mils DFT 14 mils WFT	0.88 gal/100 ft ²
Spray Foam Genie	SFG 1.7 CC™ (See Note 3)	5 ¹ / ₂	9 ¹ / ₂	9 mils DFT 14 mils WFT	0.88 gal/100 ft ²
Sustainable Polymer Products	0.5 OC (See Note 3)	8 ¹ / ₂	14	9 mils DFT 14 mils WFT	0.88 gal/100 ft ²
Sustainable Polymer Products	0.5 OCX (See Note 3)	9	14	9 mils DFT 14 mils WFT	0.88 gal/100 ft ²
Sustainable Polymer Products	2.0 CC (See Note 3)	5 ¹ / ₂	9 ¹ / ₂	9 mils DFT 14 mils WFT	0.88 gal/100 ft ²
SWD Urethane	Quik-Shield 100X (See Note 3)	7	11	12 mils DFT 18 mils WFT	1.13 gal/100 ft ²
SWD Urethane	Quik-Shield 104 (See Note 3)	8	14	12 mils DFT 18 mils WFT	1.13 gal/100 ft ²
SWD Urethane	Quik-Shield 106 (See Note 3)	11 ¹ / ₄	11 ¹ / ₄	15 mils DFT 24 mils WFT	1.50 gal/100 ft ²
SWD Urethane	Quik-Shield 108 (See Note 3)	8 ¹ / ₂	14	9 mils DFT 14 mils WFT	0.88 gal/100 ft ²
SWD Urethane	Quik-Shield 112 (See Note 3)	5 ¹ / ₂	9 ¹ / ₂	9 mils DFT 14 mils WFT	0.88 gal/100 ft ²
SWD Urethane	Quik-Shield 118 (See Note 3)	5 ¹ / ₂	9 ¹ / ₂	9 mils DFT 14 mils WFT	0.88 gal/100 ft ²
SWD Urethane	Quik-Shield 144 (See Note 3)	5 ¹ / ₂	9 ¹ / ₂	9 mils DFT 14 mils WFT	0.88 gal/100 ft ²
The Spray Market	SPM-200 (See Note 3)	7 ¹ / ₂	11 ¹ / ₂	9 mils DFT 14 mils WFT	0.88 gal/100 ft ²
Thermoseal™	ThermoSeal 500 HY (See Note 3)	8	12	13.7 mils DFT 20.5 mils WFT	1.28 gal /100 ft ²
Thermoseal™	Thermoseal OCX (See Note 3)	7 ¹ / ₂	11 ¹ / ₂	12 mils DFT 18 mils WFT	1.13 gal/100 ft ²
Thermoseal™	2000 (See Note 3)	5 ¹ / ₂	9 ¹ / ₂	9 mils DFT 14 mils WFT	0.88 gal/100 ft ²
Thermoseal™	Thermoseal CCX (See Note 3)	7 ¹ / ₂	11 ¹ / ₂	9 mils DFT 14 mils WFT	0.88 gal/100 ft ²
Thermoseal™	Thermoseal 5G (See Note 3)	5 ¹ / ₂	9 ¹ / ₂	9 mils DFT 14 mils WFT	0.88 gal/100 ft ²
Thermoseal™	Thermoseal HFO (See Note 3)	5 ¹ / ₂	9 ¹ / ₂	9 mils DFT 14 mils WFT	0.88 gal/100 ft ²
Thermoseal™	TS One (See Note 3)	5 ¹ / ₂	9 ¹ / ₂	13 mils DFT 20 mils WFT	1.25 gal/100 ft ²
Thermoseal™	TS360 (See Note 3)	8 ¹ / ₂	14	13 mils DFT 20 mils WFT	1.25 gal/100 ft ²
Thermoseal™	TS500 (See Note 3)	8	14	12 mils DFT 18 mils WFT	1.13 gal/100 ft ²
Thermoseal™	TS800 (See Note 3)	8	14	12 mils DFT 18 mils WFT	1.13 gal/100 ft ²
Universal Polymers Corporation	UPC 500 (ESR-3803)	8 ¹ / ₂	14	12 mils DFT 18 mils WFT	1.13 gal/100 ft ²
Universal Polymers Corporation	UPC 500 OCX (See Note 3)	7 ¹ / ₂	11 ¹ / ₂	13 mils DFT 20 mils WFT	1.25 gal/100 ft ²

**TABLE 1—USE OF INSULATION WITHOUT A PRESCRIPTIVE THERMAL BARRIER
(TESTED IN ACCORDANCE WITH NFPA 286) (Continued)**

INSULATION COMPANY NAME	INSULATION COMPANY NAME	INSULATION COMPANY NAME	INSULATION COMPANY NAME	INSULATION COMPANY NAME	INSULATION COMPANY NAME
Universal Polymers Corporation	UPC 2.0 High Lift (See Note 3)	8	12	11 mils DFT 16 mils WFT	1.00 gal/100 ft ²
Universal Polymers Corporation	UPC 1.7 (See Note 3)	8	12	11 mils DFT 16 mils WFT	1.00 gal/100 ft ²
Universal Polymers Corporation	UPC 2.0 (See Note 3)	8	12	12 mils DFT 18 mils WFT	1.13 gal/100 ft ²
Universal Polymers Corporation	UPC 500 Max (See Note 3)	8	14	14 mils DFT 21 mils WFT	1.31 gal/100 ft ²
Universal Polymers Corporation	UPC 2.0 HFO (See Note 3)	8	12	11 mils DFT 16 mils WFT	1.00 gal/100 ft ²
Urethane Technology Company, Inc.	UTC 7040-0.5 (ESR-3244)	5 ¹ / ₂	14 ³ / ₄	14 mils DFT 20 mils WFT	1.25 gal/100 ft ²
Urethane Technology Company, Inc.	UTC 7041-0.5 (ESR-3244)	5 ¹ / ₂	14 ³ / ₄	14 mils DFT 20 mils WFT	1.25 gal/100 ft ²
Victory Polymers Corp.	VPC-HFO (See Note 3)	7 ¹ / ₄	7 ¹ / ₄	12 mils DFT 18 mils WFT	1.13 gal/100 ft ²
Victory Polymers Corp.	VPC-50 OCHY (See Note 3)	8 ¹ / ₂	11 ¹ / ₂	9 mils DFT 14 mils WFT	0.88 gal/100 ft ²
Victory Polymers Inc.	VPC-CC SuperLift and VPC-CC SuperYield (See Note 3)	7 ¹ / ₂	11 ¹ / ₂	12 mils DFT 18 mils WFT	1.13 gal/100 ft ²
Victory Polymers Inc.	VPC-OneStroke (See Note 3)	7 ¹ / ₂	11 ¹ / ₂	12 mils DFT 18 mils WFT	1.13 gal/100 ft ²
Victory Polymers Inc.	VPC-HiR-OC (See Note 3)	8 ¹ / ₂	11 ¹ / ₂	9 mils DFT 14 mils WFT	0.88 gal/100 ft ²
Victory Polymers Inc.	VPC-50NF (ESR-4657)	7 ¹ / ₂	11 ¹ / ₂	12 mils DFT 18 mils WFT	1.13 gal/100 ft ²
Victory Polymers Inc.	VPC 50 OC (See Note 3)	10	14	8 mils DFT 14 mils WFT	0.88 gal/100 ft ²
Victory Polymers Inc.	VPC 200 OC (See Note 3)	5 ¹ / ₂	9 ¹ / ₂	9 mils DFT 14 mils WFT	0.88 gal/100 ft ²
Victory Polymers Inc.	VPC HFO High Lift (See Note 3)	7 ¹ / ₄	7 ¹ / ₄	12 mils DFT 18 mils WFT	1.13 gal/100 ft ²
Volatile Free, Inc.	VFI-714 (See Note 3)	5 ¹ / ₂	9 ¹ / ₂	9 mils DFT 14 mils WFT	0.88 gal/100 ft ²
Volatile Free, Inc.	VFI-716 (See Note 3)	8 ¹ / ₂	14	9 mils DFT 14 mils WFT	0.88 gal/100 ft ²
Xcelus	XLS-2000 HFO (See Note 3)	7 ¹ / ₄	7 ¹ / ₄	12 mils DFT 18 mils WFT	1.13 gal/100 ft ²
Xcelus	XLS-200 (See Note 3)	5 ¹ / ₂	9 ¹ / ₂	9 mils DFT 14 mils WFT	0.88 gal/100 ft ²
Xcelus	XLS 500 (See Note 3)	8	12	13.7 mils DFT 20.5 mils WFT	1.28 gal /100 ft ²
Xcelus	XLS 200 (See Note 3)	5 ¹ / ₂	9 ¹ / ₂	9 mils DFT 14 mils WFT	0.88 gal/100 ft ²
Xcelus	XLS 2000 (See Note 3)	7 ¹ / ₄	7 ¹ / ₄	12 mils DFT 18 mils WFT	1.13 gal/100 ft ²
XtremeSeal, LLC	XtremeSeal 0.4 LX (See Note 3)	8 ¹ / ₂	14	9 mils DFT 14 mils WFT	0.88 gal/100 ft ²
XtremeSeal, LLC	XtremeSeal 0.5 LX (See Note 3)	8 ¹ / ₂	14	9 mils DFT 14 mils WFT	0.88 gal/100 ft ²
XtremeSeal, LLC	XtremeSeal 2.0 LE (See Note 3)	5 ¹ / ₂	9 ¹ / ₂	9 mils DFT 14 mils WFT	0.88 gal/100 ft ²

For SI: 1 inch = 25.4 mm; 1 mil = 0.0254 mm; 1 gallon = 3.38 L; 1 ft² = 0.93 m².

Notes:

¹DFT = Dry Film Thickness; WFT = Wet Film Thickness

²As reported in the manufacturer's application instructions. Actual application rate, based upon specific project conditions, must be in accordance with the manufacturer's application instructions.

³Evaluation is limited to the NFPA 286 test data for the coated assembly described. Evaluation for compliance of the spray foam insulation with other applicable requirements of AC377 and the IBC and IRC are outside the scope of the report.

**TABLE 2—USE OF INSULATION WITHOUT A PRESCRIPTIVE IGNITION BARRIER
(TESTED IN ACCORDANCE WITH APPENDIX X OF AC377)**

INSULATION COMPANY NAME	INSULATION PRODUCT NAME	MAXIMUM THICKNESS (in.) (Vertical Surfaces and Attic Floors)	MAXIMUM THICKNESS (in.) (Underside of Roof Sheathing and/or Rafters, Underside of Floors)	DC315 COATING MINIMUM AVERAGE THICKNESS ¹ (Applied to all Foam Surfaces)	MINIMUM THEORETICAL APPLICATION RATE OF COATING ²
Acme Urethanes	WC-50 (See Note 3)	8	14	3 mils DFT 4 mils WFT	0.25 gal/100 ft ²
Barnhardt Manufacturing Company dba NCFI Polyurethanes	InsulStar® Light (12-008) (See Note 3)	8	14	4 mils DFT 7 mils WFT	0.44 gal/100 ft ²
BASF Corporation	ENERTITE® G (ESR-3102)	11½	15½	3 mils DFT 4 mils WFT	0.25 gal/100 ft ²
BASF Corporation	WALLTITE® LWP (ESR-2642)	5½	11½	3 mils DFT 4 mils WFT	0.25 gal/100 ft ²
Carlisle Spray Foam Insulation	Foamsulate 50 (See Note 3)	12	12	3 mils DFT 4 mils WFT	0.25 gal/100 ft ²
Carlisle Spray Foam Insulation	Foamsulate 70 (See Note 3)	14	14	3 mils DFT 4 mils WFT	0.25 gal/100 ft ²
Carlisle Spray Foam Insulation	SealTite PRO No Mix (See Note 3)	12	12	3 mils DFT 4 mils WFT	0.25 gal/100 ft ²
Carlisle Spray Foam Insulation	SealTite PRO No Trim 21 (See Note 3)	14	14	3 mils DFT 4 mils WFT	0.25 gal/100 ft ²
Creative Polymer Solutions	Accufoam CC (ESR-5254)	5½	9½	3 mils DFT 4 mils WFT	0.25 gal/100 ft ²
Creative Polymer Solutions	Accufoam OC (ESR-5254)	8	14	3 mils DFT 4 mils WFT	0.25 gal/100 ft ²
Creative Polymer Solutions	Accufoam AF1 (ESR-5255)	8	14	3 mils DFT 4 mils WFT	0.25 gal/100 ft ²
Creative Polymer Solutions	AirLok 45 (ESR-5253)	8	14	3 mils DFT 4 mils WFT	0.25 gal/100 ft ²
DAP Global Inc.	Touch N' Seal Class I FR (LOW GWP) Spray Foam System (ESR-3052)	3¼	3¼	4 mils DFT 6 mils WFT	0.38 gal/100 ft ²
DAP Global Inc.	Touch N' Seal HVAC 1.75 Spray Foam System (LOW GWP) (ESR-5042)	3¼	3¼	4 mils DFT 6 mils WFT	0.38 gal/100 ft ²
DuPont de Nemours, Inc.	FROTH-PAK™ (ESR-3228)	3½	3½	14 mils DFT 20 mils WFT	1.25 gal/100 ft ²
Dynamo Polyurethanes	Dynamo 500 No Mix OC (See Note 3)	7¾	11½	3 mils DFT 4 mils WFT	0.25 gal/100 ft ²
Elastochem Specialty Chemicals, Inc	Elastochem 500 (See Note 3)	7¾	11½	3 mils DFT 4 mils WFT	0.25 gal/100 ft ²
Elastochem Specialty Chemicals, Inc	Insulthane 450NM (See Note 3)	7¾	11½	3 mils DFT 4 mils WFT	0.25 gal/100 ft ²
Enerlab - USA	Ecothane 500 (See Note 3)	8	14	4 mils DFT 7 mils WFT	0.44 gal/100 ft ²
Foam Suppliers	EcoStar CC (See Note 3)	7½	11½	3 mils DFT 4 mils WFT	0.25 gal/100 ft ²
Foam Suppliers	Genfoam OC (See Note 3)	8½	14	4 mils DFT 6 mils WFT	0.38 gal/100 ft ²
General Coatings Manufacturing Corp.	Ultrathane 050 (See Note 3)	6	8	3 mils DFT 4 mils WFT	0.25 gal/100 ft ²
General Coatings Manufacturing Corp.	Ultra-Thane 230 (See Note 3)	7½	11½	3 mils DFT 4 mils WFT	0.25 gal/100 ft ²
General Coatings Manufacturing Corp.	Ultra-Thane 202 (See Note 3)	7½	11½	3 mils DFT 4 mils WFT	0.25 gal/100 ft ²
General Coatings Manufacturing Corp.	Ultra-Thane 205 HFO/UPC 2.0 HFO (See Note 3)	8	12	4 mils DFT 6 mils WFT	0.38 gal/100 ft ²
General Coatings Manufacturing Corp.	Ultra-Thane 205 HFO High Lift / UPC 2.0 HFO High Lift (See Note 3)	8	12	4 mils DFT 6 mils WFT	0.38 gal/100 ft ²
Green Valley Products LLC	GVP500NM (See Note 3)	10	16	4 mils DFT 6 mils WFT	0.38 gal/100 ft ²

**TABLE 2—USE OF INSULATION WITHOUT A PRESCRIPTIVE IGNITION BARRIER
(TESTED IN ACCORDANCE WITH APPENDIX X OF AC377) (Continued)**

INSULATION COMPANY NAME	INSULATION PRODUCT NAME	MAXIMUM THICKNESS (in.) (Vertical Surfaces and Attic Floors)	MAXIMUM THICKNESS (in.) (Underside of Roof Sheathing and/or Rafters, Underside of Floors)	DC315 COATING MINIMUM AVERAGE THICKNESS ¹ (Applied to all Foam Surfaces)	MINIMUM THEORETICAL APPLICATION RATE OF COATING ²
Holcim Solutions and Products US, LLC, Building Envelope Division	SES Foam 0.5 lb (See Note 3)	9½	11½	3 mils DFT 4 mils WFT	0.25 gal/100 ft²
Holcim Solutions and Products US, LLC, Building Envelope Division	Gaco Green 052N (See Note 3)	11¼	11¼	3 mils DFT 4 mils WFT	0.25 gal/100 ft²
Holcim Solutions and Products US, LLC, Building Envelope Division	GacoEZSpray F4500 (See Note 3)	12	16	3 mils DFT 4 mils WFT	0.25 gal/100 ft²
Huntsman Building Solutions	Sealection® NM (ESR-2668)	10	12	4 mils DFT 6 mils WFT	0.38 gal/100 ft²
Huntsman Building Solutions	Classic (ESR-1826)	5½	14	3 mils DFT 4 mils WFT	0.25 gal/100 ft²
Huntsman Building Solutions	Classic Plus (ESR-1826)	8	14	3 mils DFT 4 mils WFT	0.25 gal/100 ft²
Huntsman Building Solutions	Classic Ultra (ESR-1826)	5½	14	3 mils DFT 4 mils WFT	0.25 gal/100 ft²
Huntsman Building Solutions	Classic Ultra Select (ESR-1826)	5½	14	3 mils DFT 4 mils WFT	0.25 gal/100 ft²
Huntsman Building Solutions	Agribalance® (ESR-2600)	7½	11½	3 mils DFT 4 mils WFT	0.25 gal/100 ft²
Huntsman Building Solutions	SELECTION® 500 (ESR-1172)	7½	11½	3 mils DFT 4 mils WFT	0.25 gal/100 ft²
Huntsman Building Solutions	Foam-Lok FL 450 (ESR-4242)	5½	14	3 mils DFT 4 mils WFT	0.25 gal/100 ft²
Huntsman Building Solutions	Prime Gold (See Note 3)	5½	14	3 mils DFT 4 mils WFT	0.25 gal/100 ft²
Huntsman Building Solutions	Foam-Lok FL500 (ESR-2847)	5½	11½	3 mils DFT 4 mils WFT	0.25 gal/100 ft²
Huntsman Building Solutions	AirTight OC (ESR-2847)	5½	11½	3 mils DFT 4 mils WFT	0.25 gal/100 ft²
Huntsman Building Solutions	GUARDFOAM 55 OC (ESR-2847)	5½	11½	3 mils DFT 4 mils WFT	0.25 gal/100 ft²
Huntsman Building Solutions	Open Cell Retrofit Foam (ESR-2847)	5½	11½	3 mils DFT 4 mils WFT	0.25 gal/100 ft²
Huntsman Building Solutions	ProSeal (ESR-3500)	8	14	3 mils DFT 4 mils WFT	0.25 gal/100 ft²
Huntsman Building Solutions	ProSeal LE (ESR-3500)	8	14	3 mils DFT 4 mils WFT	0.25 gal/100 ft²
Huntsman Building Solutions	Icynene Classic 45 (ESR-5498)	5½	14	3 mils DFT 4 mils WFT	0.25 gal/ 100 ft²
Huntsman Building Solutions	Icynene OC No-Mix (ESR-5499)	5½	11½	3 mils DFT 4 mils WFT	0.25 gal/ 100 ft²
Huntsman Building Solutions	Icynene Ultra 50 (ESR-5497)	7½	11½	3 mils DFT 4 mils WFT	0.25 gal/ 100 ft²
Huntsman Building Solutions	Icynene Classic 75 (ESR-5495)	8	14	3 mils DFT 4 mils WFT	0.25 gal/ 100 ft²
Huntsman Building Solutions	Icynene High-R 80 (ESR-5494)	7½	11½	3 mils DFT 4 mils WFT	0.25 gal/ 100 ft²
Huntsman Building Solutions	Foam-Lok FL 750 (ESR-4322)	8	14	3 mils DFT 4 mils WFT	0.25 gal/ 100 ft²
Huntsman Building Solutions	Foam-LOK FL2000-3G (ESR-4501)	8	14	3 mils DFT 4 mils WFT	0.25 gal/ 100 ft²
ICP Construction Inc., dba ICP Building Solutions Group	HandiFoam HVLP MD 2.0 (See Note 3)	5½	11½	3 mils DFT 4 mils WFT	0.25 gal/100 ft²
ICP Construction Inc., dba ICP Building Solutions Group	HandiFoam HVLP HFO 2.0 (See Note 3)	5½	11½	3 mils DFT 4 mils WFT	0.25 gal/100 ft²
IPS Innovative Polymer Systems	IPS 500 Max (See Note 3)	7¾	11½	3 mils DFT 4 mils WFT	0.25 gal/100 ft²
IPS Innovative Polymer Systems	IPS 500 EZ (See Note 3)	7¾	11½	3 mils DFT 4 mils WFT	0.25 gal/100 ft²
Johns Manville	JM Corbond III (See Note 3)	7½	9½	3 mils DFT 4 mils WFT	0.25 gal/100 ft²

**TABLE 2—USE OF INSULATION WITHOUT A PRESCRIPTIVE IGNITION BARRIER
(TESTED IN ACCORDANCE WITH APPENDIX X OF AC377) (Continued)**

INSULATION COMPANY NAME	INSULATION PRODUCT NAME	MAXIMUM THICKNESS (in.) (Vertical Surfaces and Attic Floors)	MAXIMUM THICKNESS (in.) (Underside of Roof Sheathing and/or Rafters, Underside of Floors)	DC315 COATING MINIMUM AVERAGE THICKNESS ¹ (Applied to all Foam Surfaces)	MINIMUM THEORETICAL APPLICATION RATE OF COATING ²
Johns Manville	JM MCS+ (See Note 3)	7½	9½	3 mils DFT 4 mils WFT	0.25 gal/100 ft ²
Natural Polymers, LLC	Natural-Therm™ HFO (See Note 3)	7½	11½	3 mils DFT 4 mils WFT	0.25 gal/100 ft ²
Natural Polymers, LLC	Natural-Therm™ ZERO (See Note 3)	7½	11½	3 mils DFT 4 mils WFT	0.25 gal/100 ft ²
PCC Prodex S.P z.o.o.	Crossin 450 (See Note 3)	8	14	3 mils DFT 4 mils WFT	0.25 gal/100 ft ²
Polygreen Solutions	GreenSeal 44 (See Note 3)	8	14	3 mils DFT 4 mils WFT	0.25 gal/100 ft ²
Profoam	ProFill Plus (See Note 3)	8	14	3 mils DFT 4 mils WFT	0.25 gal/100 ft ²
Purinova Sp. Z.o.o.	Purinova PURIOS 500 (See Note 3)	8	14	3 mils DFT 4 mils WFT	0.25 gal/100 ft ²
Rhino Linings Corporation	ThermalGuard OC .5 (ESR-2100)	8	12	3 mils DFT 4 mils WFT	0.25 gal/100 ft ²
Rhino Linings Corporation	ThermalGuard 1.0 (See Note 3)	8	12	3 mils DFT 4 mils WFT	0.25 gal/100 ft ²
Rhino Linings Corporation	Thermal Guard OC 1.0 (ESR-4209)	8½	14	3 mils DFT 4 mils WFT	0.25 gal/100 ft ²
SFM Foam	OC NM Pro (See Note 3)	7¾	11½	3 mils DFT 4 mils WFT	0.25 gal/100 ft ²
SFM Foam	OC Pro (See Note 3)	7¾	11½	3 mils DFT 4 mils WFT	0.25 gal/100 ft ²
Spray Foam Genie	SFG 0.5 OC (See Note 3)	8	14	4 mils DFT 7 mils WFT	0.44 gal/100 ft ²
Soudal Accumetric	Soudafoam MAXTWO HFO E84 (ESR-4728)	2	2	3 mils DFT 4 mils WFT	0.25 gal/100 ft ²
Soudal Accumetric	Soudafoam MAXTWO HFO XL E84 (ESR-4728)	2	2	3 mils DFT 4 mils WFT	0.25 gal/100 ft ²
Sustainable Polymer Products	0.5 OC HY (See Note 3)	9½	11½	3 mils DFT 4 mils WFT	0.25 gal/100 ft ²
SWD Urethane	Quik-Shield 108 (See Note 3)	8	12	3 mils DFT 4 mils WFT	0.25 gal/100 ft ²
Thermoseal™	ThermoSeal 500 HY	7¾	11½	3 mils DFT 4 mils WFT	0.25 gal/100 ft ²
Thermoseal™	TS 360 (See Note 3)	8½	14	4 mils DFT 6 mils WFT	0.38 gal/100 ft ²
Thermoseal™	TS 600 (See Note 3)	9½	14	4 mils DFT 6 mils WFT	0.38 gal/100 ft ²
Thermoseal™	TS 800 (See Note 3)	9½	14	4 mils DFT 6 mils WFT	0.38 gal/100 ft ²
Universal Polymers Corporation	UPC 500 (ESR-3803)	8½	14	4 mils DFT 6 mils WFT	0.38 gal/100 ft ²
Universal Polymers Corporation	UPC 2.0 High Lift (See Note 3)	8	12	4 mils DFT 6 mils WFT	0.38 gal/100 ft ²
Universal Polymers Corporation	UPC 2.0 (See Note 3)	7½	11½	3 mils DFT 4 mils WFT	0.25 gal/100 ft ²
Urethane Technology Company, Inc.	UTC 7040-0.5 (ESR-3244)	5½	14¾	3 mils DFT 4 mils WFT	0.25 gal/100 ft ²
Urethane Technology Company, Inc.	UTC 7041-0.5 (ESR-3244)	5½	14¾	3 mils DFT 4 mils WFT	0.25 gal/100 ft ²
Victory Polymers Corp.	VPC-50 OCHY (See Note 3)	12	12	3 mils DFT 4 mils WFT	0.25 gal/100 ft ²
Victory Polymers Inc.	VPC-OneStroke (See Note 3)	7½	11½	12 mils DFT 18 mils WFT	1.13 gal/100 ft ²
Victory Polymers Inc.	VPC-HiR-OC (See Note 3)	14	14	3 mils DFT 4 mils WFT	0.25 gal/100 ft ²
Victory Polymers Inc.	VPC-50 NF (ESR-4657)	10	12	4 mils DFT 6 mils WFT	0.38 gal/100 ft ²

**TABLE 2—USE OF INSULATION WITHOUT A PRESCRIPTIVE IGNITION BARRIER
(TESTED IN ACCORDANCE WITH APPENDIX X OF AC377) (Continued)**

INSULATION COMPANY NAME	INSULATION COMPANY NAME	INSULATION COMPANY NAME	INSULATION COMPANY NAME	INSULATION COMPANY NAME	INSULATION COMPANY NAME
Victory Polymers Inc.	VPC 50 OC (See Note 3)	7 ³ / ₄	11 ¹ / ₂	3 mils DFT 4 mils WFT	0.25 gal/100 ft ²
Xcelus	XLS 500 (See Note 3)	7 ³ / ₄	11 ¹ / ₂	3 mils DFT 4 mils WFT	0.25 gal/100 ft ²
XtremeSeal, LLC	XtremeSeal 0.4 LX (See Note 3)	8	12	3 mils DFT 4 mils WFT	0.25 gal/100 ft ²
XtremeSeal, LLC	XtremeSeal 0.5 LX (See Note 3)	9 ¹ / ₂	11 ¹ / ₂	3 mils DFT 4 mils WFT	0.25 gal/100 ft ²

For SI: 1 inch = 25.4 mm; 1 mil = 0.0254 mm; 1 gallon = 3.38 L; 1 ft² = 0.93 m².

Notes:

¹DFT = Dry Film Thickness; WFT = Wet Film Thickness

²As reported in the manufacturer's application instructions. Actual application rate, based upon specific project conditions, must be in accordance with the manufacturer's application instructions.

³Evaluation is limited to the NFPA 286 test data for the coated assembly described. Evaluation for compliance of the spray foam insulation with other applicable requirements of AC377 and the IBC and IRC are outside the scope of the report.

TABLE 3—NFPA 285 COMPLYING EXTERIOR WALL ASSEMBLIES

WALL COMPONENTS	MATERIALS
Base wall system— Use either 1, 2 or 3	1 — Concrete wall 2 — Concrete masonry wall 3 — 1 layer of 5/8-inch-thick Type X gypsum wallboard on interior, installed over minimum 35/8-inch-deep, minimum No. 20-gage steel studs spaced at a maximum of 24 inches on center with lateral bracing every 4 feet as required by the code. One Layer of minimum 1/2-inch-thick ASTM C1177 complying exterior sheathing.
Floorline firestopping	4 pcf mineral-fiber insulation friction-fit in each wall stud cavity at each floor line. Thickness must match stud cavity depth.
Cavity insulation— Use either 1, 2, 3, 4, 5, 6 or 7	1 — None 2 — Spray-applied foam plastic insulation, maximum 35/8-inch-thick of Carlisle SealTite™ Pro Closed Cell ⁶ or SealTite™ PRO HFO ⁶ applied to Base wall 3, covering the width of the stud cavity and either fully filling the stud cavity depth or partially filling the stud cavity depth leaving a maximum air space of 15/8 inches. 3 — Spray-applied foam plastic insulation, maximum 21/4-inch-thick of Huntsman Building Solutions Heatlok HFO Pro ⁶ (Closed Cell) applied to Base wall 3, covering the width of the stud cavity and partially filling the stud cavity depth leaving a maximum air space of 15/8 inches. 4 — Spray-applied foam plastic insulation, maximum 35/8-inch-thick of Thermoseal LLC Thermoseal 5G ⁶ or Thermoseal HFO ⁶ applied to Base wall system 3, 5 — Spray-applied foam plastic insulation, maximum 3-inch-thick of Thermoseal LLC Thermoseal 5G ⁶ or Thermoseal HFO ⁶ applied to Base wall systems 1 and 2 with minimum 2-inch-thick concrete or concrete masonry walls fire blocked in accordance with IBC Section 718. 6 — Fiberglass batt insulation, Class A (faced or unfaced) ¹ 7 — Mineral-fiber insulation complying with ASTM E136 ¹
Exterior Insulation – Use either 1, 2, 3 or 4	1 — Maximum 31/2-inch-thick of Carlisle SealTite™ Pro Closed Cell ⁶ or SealTite™ PRO HFO ⁶ spray foam insulation applied directly to the exterior face of the exterior sheathing of Base wall 3 or directly to the exterior face of Base wall 1 or 2. The exposed surface of the spray foam insulation must be covered with International Fireproof Technology, Inc. DC315 ² intumescent coating applied at a minimum average 16 mils wet film thickness. The DC315 ² coating must be covered with Sherwin-Williams SHER-CRYL HPA topcoat applied at a minimum average 12 mils wet film thickness. This option can be used with cavity insulation 1, 2, 6 or 7. 2 — Huntsman Building Products' Heatlok HFO Pro ⁶ Spray Foam Insulation Closed-Cell at a nominal thickness of 33/4-inches between the steel Z-girts, applied directly to the exterior face of the exterior sheathing of Base wall 3 or directly to the exterior face of Base wall 1 or 2. The exposed surface of spray foam insulation must be covered with DC315 ² intumescent coating applied at a minimum 18 mils wet film thickness. The DC315 ² coating must be covered with Sherwin-Williams SHER-CRYL HPA topcoat applied at a minimum 9 mils wet film thickness. This option can be used with cavity insulation 1, 3, 6 or 7. 3 — Gaco F1850 ccSPF ⁶ or Gaco F1880 ccSPF ⁶ Spray Foam Insulation Closed-Cell at a nominal thickness of 4 inches between the steel Z-girts, applied directly to the exterior face of the exterior sheathing of Base wall 3 or directly to the exterior face of Base wall 1 or 2. DC315 ² intumescent coating applied at a minimum 18 mils wet film thickness. The DC315 ² coating must be covered with Sherwin-Williams SHER-CRYL HPA topcoat applied at a minimum 8 mils wet film thickness. This option must be used with 1, 6 or 7. 4 — Maximum 3-inch-thick of Thermoseal LLC Thermoseal 5G ⁶ or Thermoseal HFO ⁶ spray foam insulation applied directly to the exterior face of the exterior sheathing of Base wall 3 or directly to the exterior face of Base wall 1 or 2. The exposed surface of the spray foam insulation must be covered with International Fireproof Technology, Inc. DC315 ² intumescent coating applied at a minimum average 18 mils wet film thickness. The DC315 ² coating must be covered with Sherwin-Williams SHER-CRYL HPA topcoat applied at a minimum average 8 mils wet film thickness ³ . This option can be used with cavity insulation 1, 4, 5, 6 or 7.
Exterior wall covering—Use either 1 through 14	1 — Brick —Standard nominally 4-inch-thick clay brick with brick veneer anchors installed a maximum of 24 inches on center vertically on each stud. Maximum 21/2-inch air gap between exterior insulation and brick. 2 — Cast concrete – Minimum 1-inch-thick, using any standard non-open-jointed installation. — Maximum 2-inch air gap between exterior insulation 1, 2 or 3 and cast concrete. 3 — Cast concrete – Minimum 1-inch-thick, using any standard non-open-jointed installation. — Maximum 21/2-inch air gap between exterior insulation 4 and cast concrete. 4 — Concrete masonry units – Minimum 21/2-inch-thick, using any standard non-open-jointed installation. — Maximum 3-inch air gap between exterior insulation 1, 2 or 3 and concrete masonry units. 5 — Concrete masonry units – Minimum 2-inch-thick, using any standard open or non-open-jointed installation. — Maximum 3 - inch air gap between exterior insulation 4 and concrete masonry units. 6 — Natural stone veneer – Minimum 2-inch-thick, using any standard non-open-jointed installation technique 7 — Terracotta cladding – Use any terracotta cladding system in which the terracotta is minimum 11/4-inch-thick, using any standard non-open-jointed installation technique. 8 — Stucco – Minimum 3/4 -inch-thick, code-complying three-coat exterior cement plaster and lath. 9 — Aluminum cladding panels, vertical interlocking type – Minimum 0.030-inch-thick using the framing system specified in footnote 3, 4 or 5 must be used with exterior insulation 1, 2 or 3 and/or cavity insulation. 10 — Aluminum cladding panels, vertical interlocking type – Minimum 0.080-inch-thick using the framing system specified in footnote, 3, 4 or 5 must be used with Thermoseal LLC Thermoseal 5G ⁶ or Thermoseal HFO ⁶ exterior and/or cavity insulation. 11 — Corrosion-resistant steel cladding panels, interlocking type – minimum 0.0149-inch-thick using the framing system specified in footnote 3, 4 or 5 dependent on Spray Foam used. 12 — Cold-rolled copper cladding panels, interlocking type – minimum 0.0216-inch-thick, minimum 16 ounces per square foot, using the framing system specified in footnote 3. 13 — Arconic Architectural Products, LLC Reynobond® FR 4-mm-thick ACM panels (ESR-3435) and framing system. The panels must be riveted to 13/4-inch deep, extruded aluminum rails. The attachment system must consist of aluminum clips attached to furring channel. The panels must be slid into place between the aluminum clip angles. Clip angles must be spaced a maximum of 16-inches on center horizontally along each furring channel. The ACM panel installation, 4 mm thick, hider strips constructed of the same FR core must be slid in between each panel within the aluminum rails to hide fastener heads. — Maximum 31/4-inch air gap between the panels and Carlisle SealTite™ Pro Closed Cell ⁶ or SealTite™ PRO HFO exterior insulation. 14 — Fiber-cement siding – Minimum 0.25 inches thick, using any standard non-open-jointed installation. 15 — One-coat Stucco – Minimum thickness as stated in a current ICC-ES evaluation report where the one-coat stucco has been qualified for compliance under AC11. 16 — Thin brick veneer – Minimum 1/4-inch thick, thin brick complying with ASTM C1088, adhered to minimum 3/4 -inch-thick, code-complying three-coat exterior cement plaster and lath mortar bed.
Opening Flashing	Minimum 0.030-inch-thick aluminum flashing installed at all openings to completely cover the opening header, jambs, and sill

For SI: 1 inch = 25.4 mm, 1 foot = 304.8 mm, 1 pcf = 16.01 kg/m³.

¹Insulation must comply with the applicable requirements of 2024, 2021, 2018, 2015 or 2012 IBC Section 720.2 (2009 and 2006 IBC Section 719.2).

²DC315, with protective topcoat, has been tested for and complies with the following additional properties for exterior use; accelerated weathering, resistance to humidity and thermal cycling testing in accordance with ASTM D5894, ASTM D4585 and ASTM D3346. Coating must be applied in accordance with the coating manufacturer's published installation instructions.

³Framing for Exterior wall coverings 9, 10, 11, and 12 consists of minimum 22 gage steel C-channel with 13/8-inch legs (54 mm) installed around the perimeter of any window opening or door opening through the exterior sheathing to the steel studs. 4-inch deep (101 mm), 20-gage steel Z-girts with 2-inch legs (51 mm) secured through exterior sheathing to studs at 24 inches (610 mm) on-center. Hat Channels [1-inch deep (25.4 mm), 37/8-inch tall (99 mm)] 22-gage steel hat channels

fastened at 24 inches (610 mm) on-center to the Z-girts. Z-girts may be installed horizontally or vertically. The cladding edges interlock together such that all edges and fasteners are concealed after installation. The maximum air space between the exterior face of the spray-applied foam plastic insulation and the back of the exterior wall covering cladding panels described in 8, 9, 10 and 11 must not exceed 2 1/2 inches (64 mm).

⁴Framing for Exterior wall coverings 9, 10, 11 or 12 consist of minimum 18 gage steel 4-inch C-channel with 1 1/2-inch legs (38 mm) installed around the perimeter of the exterior sheathing to the steel studs. 4-inch deep (101 mm), 18-gage steel Z-girts with 2-inch legs (51 mm) secured through exterior sheathing to studs at 24 inches (610 mm) on-center. Z-girts installed horizontally spaced 24 inches on center. The cladding edges interlock together such that all edges and fasteners are concealed after installation. The maximum air space between the exterior face of the spray-applied foam plastic insulation and the back of the exterior wall covering cladding panels described in 9, 10, 11 or 12 must not exceed 2 1/2 inches (64 mm)

⁵Framing for Exterior wall coverings 9, 10, 11 or 12 and I consist of minimum 22 gage steel 5-inch C-channel with 1 1/2 -inch legs (38 mm) installed around the perimeter of any opening through the exterior sheathing to the steel studs. 5-inch deep (127 mm), 22-gage steel Z-girts with 2-inch legs (51 mm) secured through exterior sheathing to studs at 24 inches (610 mm) on-center. Z-girts installed vertically spaced 24 inches on center. The cladding edges interlock together such that all edges and fasteners are concealed after installation. The maximum air space between the exterior face of the spray-applied foam plastic insulation and the back of the exterior wall covering cladding panels described in 9, 10, 11 or 12 must not exceed 2 3/4 inches (70 mm).

⁶Evaluation is limited to the NFPA 285 test data for the assembly described. Evaluation for compliance of the spray foam insulation with other applicable requirements of AC377 and the IBC and IRC are outside the scope of this report.

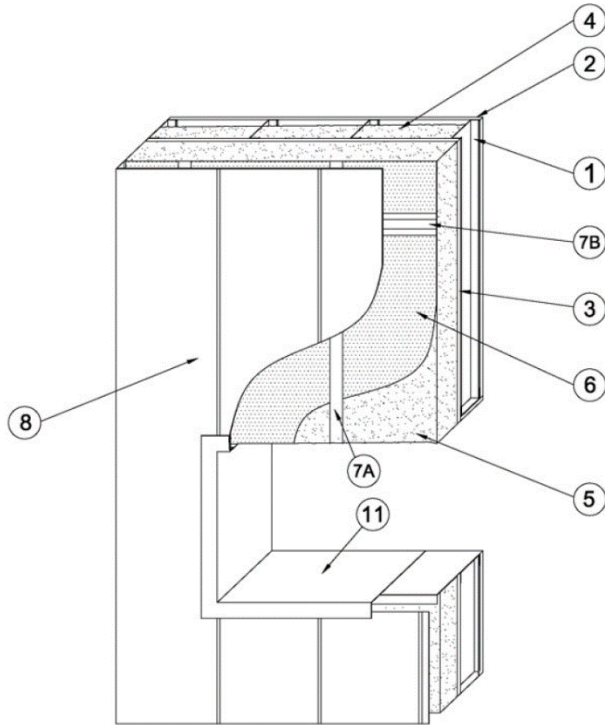

1. Steel Studs — See [Table 3](#), Base Wall System 3 (See Alternate Base Wall Systems in [Table 3](#)).
2. Interior Gypsum Board — See [Table 3](#).
3. Exterior Gypsum Sheathing — See [Table 3](#).
4. Cavity Insulation — See [Table 3](#)
5. Exterior Insulation — See [Table 3](#).
6. Exterior Insulation Intumescent Coating — See [Table 3](#), Items 2 and 3.
7. Mounting System — See [Table 3](#).
- 7A. Z-Girts and Window Channel — See [Table 3](#), Footnote 3.
- 7B. Hat Channels — See [Table 3](#), Footnote 3.
8. Exterior Cladding — See [Table 3](#) Claddings 8, 9, 10 11, or 12(Other Claddings in [Table 3](#) are not shown)
10. Floorline Firestopping — See [Table 3](#).
11. Window Flashing — See [Table 3](#), Footnote 3.

FIGURE 1—TABLE 3 (COMPONENTS)*

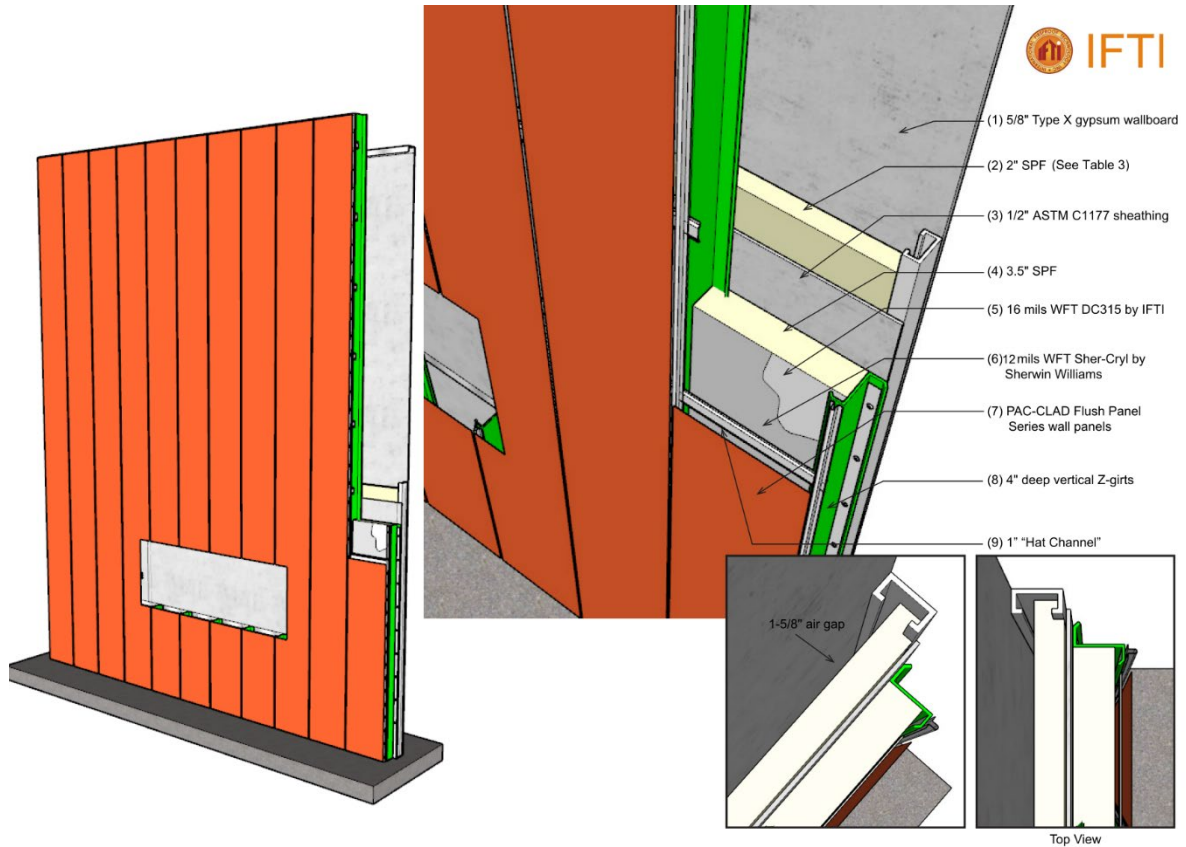

FIGURE 2—TABLE 3 (WALL DETAILS)*

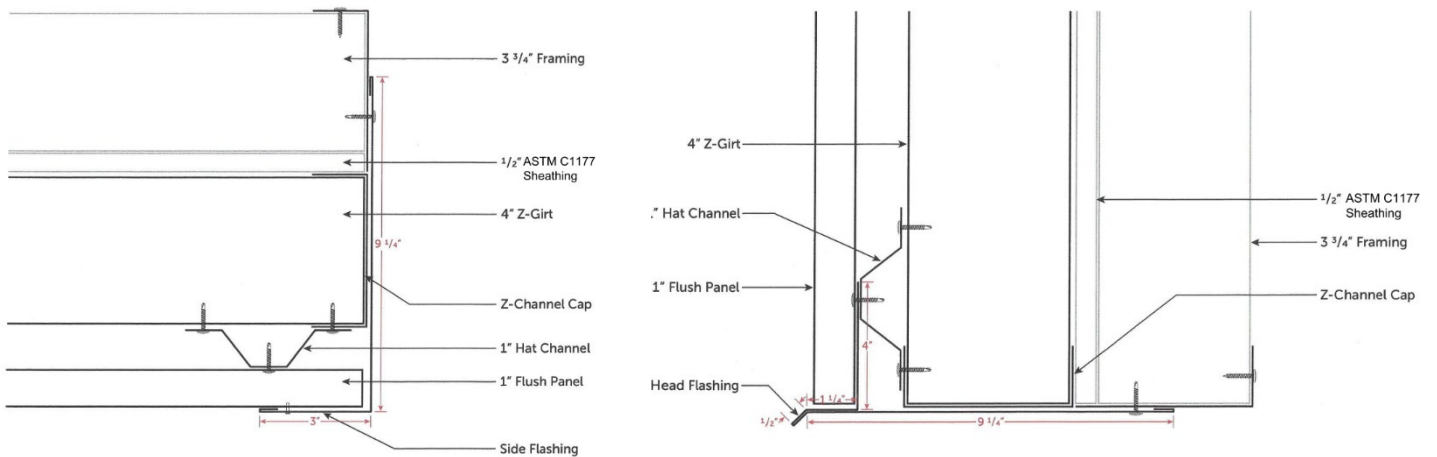
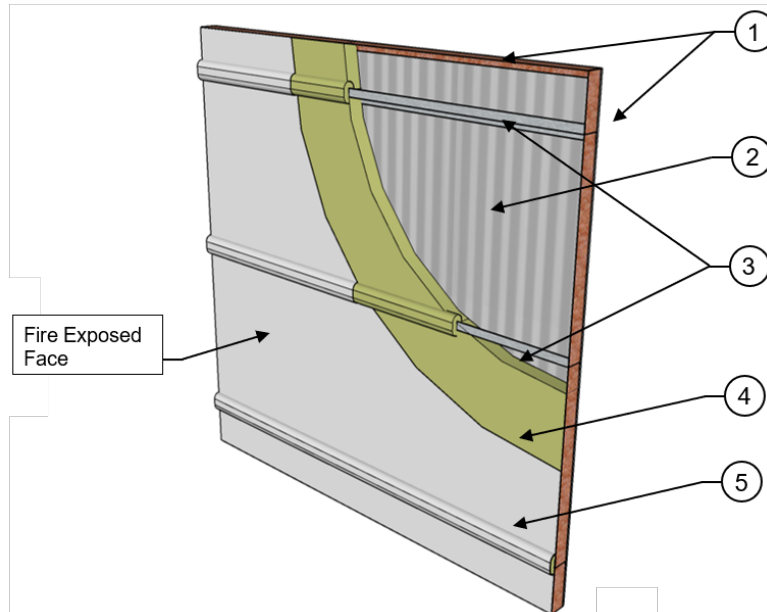

FIGURE 3—TABLE 3 (OPENING DETAILS)*

*In the event of conflict between the written descriptions in [Table 3](#) and the Figure, the written description applies.

Assembly No.:	Assembly No. 1 (Asymmetrical)
Applicant:	INTERNATIONAL FIREPROOF TECHNOLOGY INC.
Product:	DC315 INTUMESCENT COATING
Code Section:	2024 IBC Section 705.8 (2021, 2018, 2015, 2012 and 2009 IBC Section 705.7)
Assembly Rating:	1-Hour from the Fire Exposed Face (Asymmetrical Wall Assembly) where protected openings are not limited by 2024 IBC Section 705.9 (2021, 2018, 2015, 2012 and 2009 IBC Section 705.8). 1-Hour from the Fire Exposed Face (Asymmetrical Wall Assembly) where protected openings are limited by 2024 IBC Section 705.9 (2021, 2018, 2015, 2012 and 2009 IBC Section 705.8) and correction is made to the area of protected openings in accordance with 2024 IBC Section 705.8 (2021, 2018, 2015, 2012 and 2009 IBC Section 705.7) using $F_{EO} = 0.034$. (Note: See Conditions of Use – Sections 5.5 and 5.6)
Load:	Non-loadbearing



COMPONENTS OF CONSTRUCTION:

- Perimeter Framing Members** – Minimum 16-gauge thick steel members with minimum 4-inch by 2-inch (101.6 mm by 50.8 mm) legs are used as perimeter framing for the wall assembly. The perimeter framing members are oriented to allow for wall sheathing attachment and secured to each other using minimum two 1/2-inch (12.7 mm) long No. 8 pan head self-drilling screws at each corner.
- Wall Sheathing (Unexposed Face)** – Minimum 26-gauge thick and 36-inch (914.4 mm) wide commercial grade steel R-panels with 1/4-inch (31.8 mm) deep ribs must be installed vertically with panel seams overlapping in accordance with the manufacturer's published installation instructions. Panels must be secured to each other along the vertical overlapping seam using 1-inch (25.4 mm) long No. 12 external hex washer head self-drilling screws spaced at a maximum of 16-inches (406.4 mm) on center vertically. Panels are secured to the perimeter framing members using 1-inch (25.4 mm) long No. 12 external hex washer head self-drilling screws spaced at a maximum of 16-inches (406.4 mm) on center around the perimeter of the wall assembly. Panels must be secured to the intermediate support framing using 1 1/2-inch (38.1 mm) long No. 12-14 external hex washer head self-drilling screws spaced at a maximum of 12-inches (304.8 mm) on center horizontally along each intermediate support framing member.
- Intermediate Support Framing** – Intermediate wall framing members consist of minimum 16-gauge thick, 4-inch (101.6 mm) deep Z- or C-girts with 2-inch (50.8 mm) legs installed horizontally and spaced at a maximum of 48-inches (1219.2 mm) on center. The intermediate support framing members are secured to the perimeter framing members using minimum two 1/2-inch (12.7 mm) long No. 8 pan head self-drilling screws at each end.
- Insulation** – GENYK Elite 2.0 (Closed-Cell) ([ESR-5150](#)) spray-applied polyurethane foam (SPF) insulation, with a reported density of 2.0 lbs./ft³ (32.04 kg/m³), must be applied at a nominal thickness of 4-inches (101.6 mm) between the intermediate support framing members, applied directly to the fire exposed face of the wall sheathing. SPF insulation must also be applied to the intermediate support framing members at a nominal thickness of 1 1/2-inch (38.1 mm) matching the contour of the Z- or C-girts. Application must be in accordance with the manufacturer's published instructions.
- Intumescent Coating (Exposed Face)** – International Fireproof Technology Inc. DC315 intumescent coating must be applied over the exposed surface of the spray foam insulation at a minimum 24 mils [0.024-inch (0.61 mm)] dry film thickness (DFT) on the fire exposed face of the wall assembly. Application must be in accordance with the manufacturer's published instructions.

FIGURE 4—NON-LOADBEARING WALL ASSEMBLY No 1 CONSTRUCTION DETAILS

Assembly No.:	Assembly No. 2 (Asymmetrical)
Applicant:	INTERNATIONAL FIREPROOF TECHNOLOGY INC.
Product:	DC315 INTUMESCENT COATING
Code Section:	2024 IBC Section 705.8 (2021, 2018, 2015, 2012 and 2009 IBC Section 705.7)
Assembly Rating:	1-Hour from the Fire Exposed Face (Asymmetrical Wall Assembly) where protected openings are not limited by 2024 IBC Section 705.9 (2021, 2018, 2015, 2012 and 2009 IBC Section 705.8). 1-Hour from the Fire Exposed Face (Asymmetrical Wall Assembly) where protected openings are limited by 2024 IBC Section 705.9 (2021, 2018, 2015, 2012 and 2009 IBC Section 705.8) and correction is made to the area of protected openings in accordance with 2024 IBC Section 705.8 (2021, 2018, 2015, 2012 and 2009 IBC Section 705.7) using $F_{EO} = 0.016$, (Note: See Conditions of Use – Sections 5.5 and 5.6)
Load:	Non-loadbearing

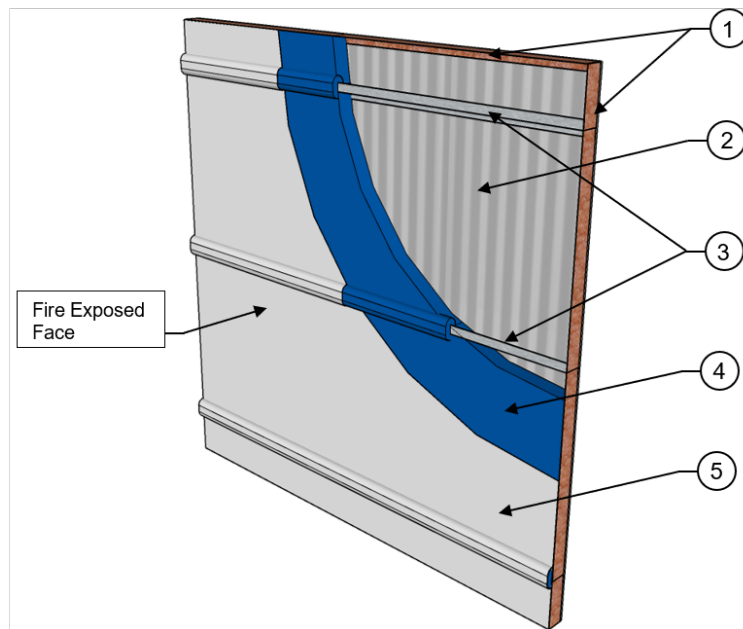

COMPONENTS OF CONSTRUCTION:

1. **Perimeter Framing Members** – Minimum 16-gauge thick steel members with minimum 4-inch by 2-inch (101.6 mm by 50.8 mm) legs are used as perimeter framing for the wall assembly. The perimeter framing members are oriented to allow for wall sheathing attachment and secured to each other using minimum two 1/2-inch (12.7 mm) long No. 8 pan head self-drilling screws at each corner.
2. **Wall Sheathing (Unexposed Face)** – Minimum 26-gauge thick and 36-inch (914.4 mm) wide commercial grade steel R-panels with 1 1/4-inch (31.8 mm) deep ribs must be installed vertically with panel seams overlapping in accordance with the manufacturer's published installation instructions. Panels must be secured to each other along the vertical overlapping seam using 1-inch (25.4 mm) long No. 12 external hex washer head self-drilling screws spaced at a maximum of 16-inches (406.4 mm) on center vertically. Panels are secured to the perimeter framing members using 1-inch (25.4 mm) long No. 12 external hex washer head self-drilling screws spaced at a maximum of 16-inches (406.4 mm) on center around the perimeter of the wall assembly. Panels must be secured to the intermediate support framing using 1 1/2-inch (38.1 mm) long No. 12-14 external hex washer head self-drilling screws spaced at a maximum of 12-inches (304.8 mm) on center horizontally along each intermediate support framing member.
3. **Intermediate Support Framing** – Intermediate wall framing members consist of minimum 16-gauge thick, 4-inch (101.6 mm) deep Z- or C-girts with 2-inch (50.8 mm) legs installed horizontally and spaced at a maximum of 48-inches (1219.2 mm) on center. The intermediate support framing members are secured to the perimeter framing members using minimum two 1/2-inch (12.7 mm) long No. 8 pan head self-drilling screws at each end.
4. **Insulation** – Carlisle SealTite™ PRO HFO (Closed-Cell) spray-applied polyurethane foam (SPF) insulation, with a reported density of 2.07 lbs./ft³ (33.16 kg/m³), must be applied at a nominal thickness of 4-inches (101.6 mm) between the intermediate support framing members, applied directly to the fire exposed face of the wall sheathing. SPF insulation must also be applied to the intermediate support framing members at a nominal thickness of 1 1/2-inch (38.1 mm) matching the contour of the Z- or C-girts. Application must be in accordance with the manufacturer's published instructions. **Note: Evaluation Carlisle SealTite™ PRO HFO (Closed-Cell) SPF is limited to the ASTM E119 test data for the coated assembly described. Evaluation for compliance of the spray foam insulation with other applicable requirements of AC377 and the IBC and IRC are outside the scope of this report.**
5. **Intumescent Coating (Exposed Face)** – International Fireproof Technology Inc. DC315 intumescent coating must be applied over the exposed surface of the spray foam insulation at a minimum 27 mils [0.027-inch (0.69 mm)] dry film thickness (DFT) on the fire exposed face of the wall assembly. Application must be in accordance with the manufacturer's published instructions.

FIGURE 5— NON-LOADBEARING WALL ASSEMBLY No. 2 CONSTRUCTION DETAILS

Assembly No.:	Assembly No. 3 (Asymmetrical)
Applicant:	INTERNATIONAL FIREPROOF TECHNOLOGY INC.
Product:	DC315 INTUMESCENT COATING
Code Section:	2024 IBC Section 705.8 (2021, 2018, 2015, 2012 and 2009 IBC Section 705.7)
Assembly Rating:	1-Hour from the Fire Exposed Face (Asymmetrical Wall Assembly) where protected openings are not limited by 2024 IBC Section 705.9 (2021, 2018, 2015, 2012 and 2009 IBC Section 705.8). 1-Hour from the Fire Exposed Face (Asymmetrical Wall Assembly) where protected openings are limited by 2024 IBC Section 705.9 (2021, 2018, 2015, 2012 and 2009 IBC Section 705.8) and correction is made to the area of protected openings in accordance with 2024 IBC Section 705.8 (2021, 2018, 2015, 2012 and 2009 IBC Section 705.7) using $F_{EO} = 0.018$, (Note: See Conditions of Use – Sections 5.5 and 5.6)
Load:	Non-loadbearing

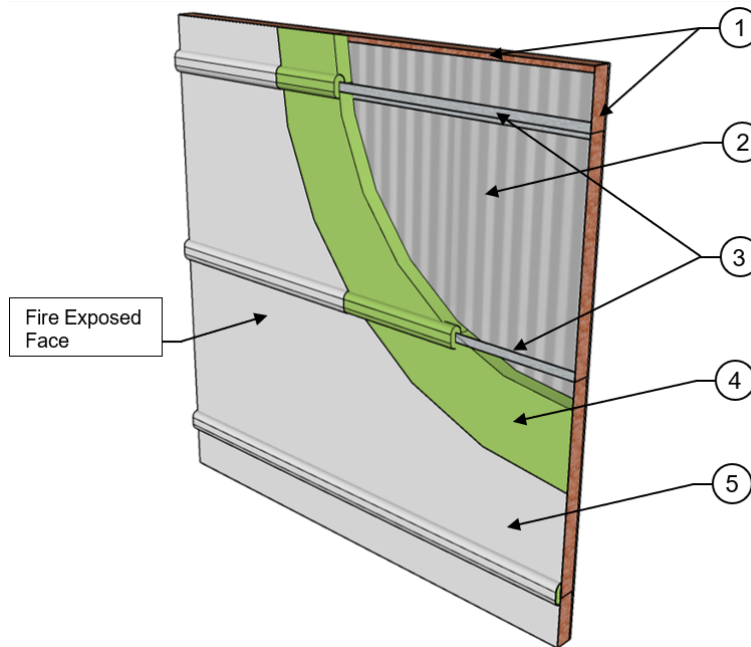

COMPONENTS OF CONSTRUCTION:

- Perimeter Framing Members** – Minimum 16-gauge thick steel members with minimum 4-inch by 2-inch (101.6 mm by 50.8 mm) legs are used as perimeter framing for the wall assembly. The perimeter framing members are oriented to allow for wall sheathing attachment and secured to each other using minimum two 1/2-inch (12.7 mm) long No. 8 pan head self-drilling screws at each corner.
- Wall Sheathing (Unexposed Face)** – Minimum 26-gauge thick and 36-inch (914.4 mm) wide commercial grade steel R-panels with 1 1/4-inch (31.8 mm) deep ribs must be installed vertically with panel seams overlapping in accordance with the manufacturer's published installation instructions. Panels must be secured to each other along the vertical overlapping seam using 1-inch (25.4 mm) long No. 12 external hex washer head self-drilling screws spaced at a maximum of 16-inches (406.4 mm) on center vertically. Panels are secured to the perimeter framing members using 1-inch (25.4 mm) long No. 12 external hex washer head self-drilling screws spaced at a maximum of 16-inches (406.4 mm) on center around the perimeter of the wall assembly. Panels must be secured to the intermediate support framing using 1 1/2-inch (38.1 mm) long No. 12-14 external hex washer head self-drilling screws spaced at a maximum of 12-inches (304.8 mm) on center horizontally along each intermediate support framing member.
- Intermediate Support Framing** – Intermediate wall framing members consist of minimum 16-gauge thick, 4-inch (101.6 mm) deep Z- or C-girts with 2-inch (50.8 mm) legs installed horizontally and spaced at a maximum of 48-inches (1219.2 mm) on center. The intermediate support framing members are secured to the perimeter framing members using minimum two 1/2-inch (12.7 mm) long No. 8 pan head self-drilling screws at each end.
- Insulation** – Carlisle SealTite™ One (Closed-Cell) spray-applied polyurethane foam (SPF) insulation, with a reported density of 2.30 lbs./ft³ (36.84 kg/m³), must be applied at a nominal thickness of 4-inches (101.6 mm) between the intermediate support framing members, applied directly to the fire exposed face of the wall sheathing. SPF insulation must also be applied to the intermediate support framing members at a nominal thickness of 1 1/2-inch (38.1 mm) matching the contour of the Z- or C-girts. Application must be in accordance with the manufacturer's published instructions. **Note: Evaluation Carlisle SealTite™ One (Closed-Cell) SPF is limited to the ASTM E119 test data for the coated assembly described. Evaluation for compliance of the spray foam insulation with other applicable requirements of AC377 and the IBC and IRC are outside the scope of this report.**
- Intumescent Coating (Exposed Face)** – International Fireproof Technology Inc. DC315 intumescent coating must be applied over the exposed surface of the spray foam insulation at a minimum 24 mils [0.024-inch (0.61 mm)] dry film thickness (DFT) on the fire exposed face of the wall assembly. Application must be in accordance with the manufacturer's published instructions.

FIGURE 6— NON-LOADBEARING WALL ASSEMBLY No. 3 CONSTRUCTION DETAILS

Assembly No.:	Assembly No. 4 (Asymmetrical)
Applicant:	INTERNATIONAL FIREPROOF TECHNOLOGY INC.
Product:	DC315 INTUMESCENT COATING
Code Section:	2024 IBC Section 705.8 (2021, 2018, 2015, 2012 and 2009 IBC Section 705.7)
Assembly Rating:	1-Hour from the Fire Exposed Face (Asymmetrical Wall Assembly) where protected openings are not limited by 2024 IBC Section 705.9 (2021, 2018, 2015, 2012 and 2009 IBC Section 705.8). 1-Hour from the Fire Exposed Face (Asymmetrical Wall Assembly) where protected openings are limited by 2024 IBC Section 705.9 (2021, 2018, 2015, 2012 and 2009 IBC Section 705.8) and correction is made to the area of protected openings in accordance with 2024 IBC Section 705.8 (2021, 2018, 2015, 2012 and 2009 IBC Section 705.7) using $F_{EO} = 0.01$, (Note: See Conditions of Use – Sections 5.5 and 5.6)
Load:	Non-loadbearing

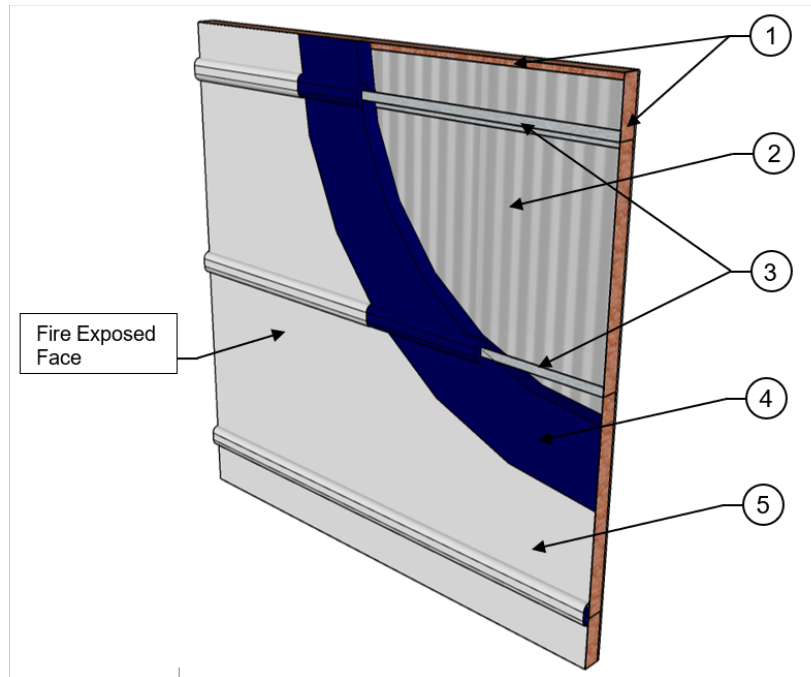

COMPONENTS OF CONSTRUCTION:

1. **Perimeter Framing Members** – Minimum 16-gauge thick steel members with minimum 4-inch by 2-inch (101.6 mm by 50.8 mm) legs are used as perimeter framing for the wall assembly. The perimeter framing members are oriented to allow for wall sheathing attachment and secured to each other using minimum two 1/2-inch (12.7 mm) long No. 8 pan head self-drilling screws at each corner.
2. **Wall Sheathing (Unexposed Face)** – Minimum 26-gauge thick and 36-inch (914.4 mm) wide commercial grade steel R-panels with 1 1/4-inch (31.8 mm) deep ribs must be installed vertically with panel seams overlapping in accordance with the manufacturer's published installation instructions. Panels must be secured to each other along the vertical overlapping seam using 1-inch (25.4 mm) long No. 12 external hex washer head self-drilling screws spaced at a maximum of 16-inches (406.4 mm) on center vertically. Panels are secured to the perimeter framing members using 1-inch (25.4 mm) long No. 12 external hex washer head self-drilling screws spaced at a maximum of 16-inches (406.4 mm) on center around the perimeter of the wall assembly. Panels must be secured to the intermediate support framing using 1 1/2-inch (38.1 mm) long No. 12-14 external hex washer head self-drilling screws spaced at a maximum of 12-inches (304.8 mm) on center horizontally along each intermediate support framing member.
3. **Intermediate Support Framing** – Intermediate wall framing members consist of minimum 16-gauge thick, 4-inch (101.6 mm) deep Z- or C-girts with 2-inch (50.8 mm) legs installed horizontally and spaced at a maximum of 48-inches (1219.2 mm) on center. The intermediate support framing members are secured to the perimeter framing members using minimum two 1/2-inch (12.7 mm) long No. 8 pan head self-drilling screws at each end.
4. **Insulation** – Elastochem Insulthane® Extreme (Closed-Cell) spray-applied polyurethane foam (SPF) insulation, with a reported density of 2.18 lbs./ft³ (34.92 kg/m³), must be applied at a nominal thickness of 4-inches (101.6 mm) between the intermediate support framing members, applied directly to the fire exposed face of the wall sheathing. SPF insulation must also be applied to the intermediate support framing members at a nominal thickness of 1 1/2-inch (38.1 mm) matching the contour of the Z- or C-girts. Application must be in accordance with the manufacturer's published instructions. **Note: Evaluation of Elastochem Insulthane® Extreme (Closed Cell) SPF is limited to the ASTM E119 test data for the coated assembly described. Evaluation for compliance of the spray foam insulation with other applicable requirements of AC377 and the IBC and IRC are outside the scope of this report.**
5. **Intumescent Coating (Exposed Face)** – International Fireproof Technology Inc. DC315 intumescent coating must be applied over the exposed surface of the spray foam insulation at a minimum 24 mils [0.024-inch (0.61 mm)] dry film thickness (DFT) on the fire exposed face of the wall assembly. Application must be in accordance with the manufacturer's published instructions.

FIGURE 7— NON-LOADBEARING WALL ASSEMBLY No. 4 CONSTRUCTION DETAILS

Assembly No.:	Assembly No. 5 (Asymmetrical)
Applicant:	INTERNATIONAL FIREPROOF TECHNOLOGY INC.
Product:	DC315 INTUMESCENT COATING
Code Section:	2024 IBC Section 705.8 (2021, 2018, 2015, 2012 and 2009 IBC Section 705.7)
Assembly Rating:	1-Hour from the Fire Exposed Face (Asymmetrical Wall Assembly) where protected openings are not limited by 2024 IBC Section 705.9 (2021, 2018, 2015, 2012 and 2009 IBC Section 705.8). 1-Hour from the Fire Exposed Face (Asymmetrical Wall Assembly) where protected openings are limited by 2024 IBC Section 705.9 (2021, 2018, 2015, 2012 and 2009 IBC Section 705.8) and correction is made to the area of protected openings in accordance with 2024 IBC Section 705.8 (2021, 2018, 2015, 2012 and 2009 IBC Section 705.7) using $F_{EO} = 0.01$, (Note: See Conditions of Use – Sections 5.5 and 5.6)
Load:	Non-loadbearing

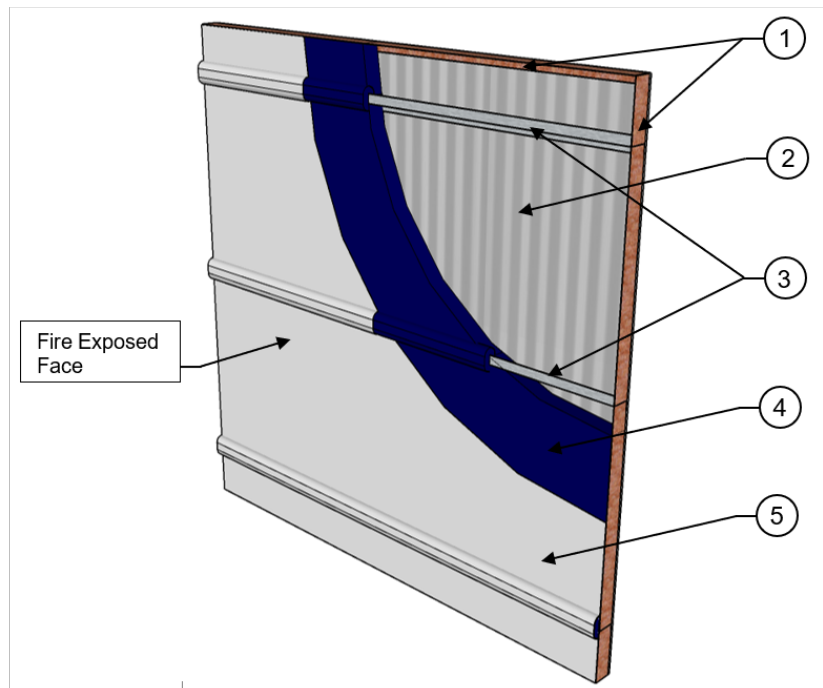

COMPONENTS OF CONSTRUCTION:

- Perimeter Framing Members** – Minimum 16-gauge thick steel members with minimum 4-inch by 2-inch (101.6 mm by 50.8 mm) legs are used as perimeter framing for the wall assembly. The perimeter framing members are oriented to allow for wall sheathing attachment and secured to each other using minimum two $\frac{1}{2}$ -inch (12.7 mm) long No. 8 pan head self-drilling screws at each corner.
- Wall Sheathing (Unexposed Face)** – Minimum 26-gauge thick and 36-inch (914.4 mm) wide commercial grade steel R-panels with $1\frac{1}{4}$ -inch (31.8 mm) deep ribs must be installed vertically with panel seams overlapping in accordance with the manufacturer's published installation instructions. Panels must be secured to each other along the vertical overlapping seam using 1-inch (25.4 mm) long No. 12 external hex washer head self-drilling screws spaced at a maximum of 16-inches (406.4 mm) on center vertically. Panels are secured to the perimeter framing members using 1-inch (25.4 mm) long No. 12 external hex washer head self-drilling screws spaced at a maximum of 16-inches (406.4 mm) on center around the perimeter of the wall assembly. Panels must be secured to the intermediate support framing using $1\frac{1}{2}$ -inch (38.1 mm) long No. 12-14 external hex washer head self-drilling screws spaced at a maximum of 12-inches (304.8 mm) on center horizontally along each intermediate support framing member.
- Intermediate Support Framing** – Intermediate wall framing members consist of minimum 16-gauge thick, 4-inch (101.6 mm) deep Z- or C-girts with 2-inch (50.8 mm) legs installed horizontally and spaced at a maximum of 48-inches (1219.2 mm) on center. The intermediate support framing members are secured to the perimeter framing members using minimum two $\frac{1}{2}$ -inch (12.7 mm) long No. 8 pan head self-drilling screws at each end.
- Insulation** – Xcelus XLS 2000 HFO spray-applied polyurethane foam (SPF) insulation, with a reported density of 2.18 lbs./ft³ (34.92 kg/m³), must be applied at a nominal thickness of 4-inches (101.6 mm) between the intermediate support framing members, applied directly to the fire exposed face of the wall sheathing. SPF insulation must also be applied to the intermediate support framing members at a nominal thickness of $1\frac{1}{2}$ -inch (38.1 mm) matching the contour of the Z- or C-girts. Application must be in accordance with the manufacturer's published instructions. **Note: Evaluation of Xcelus XLS 2000 HFO SPF is limited to the ASTM E119 test data for the coated assembly described. Evaluation for compliance of the spray foam insulation with other applicable requirements of AC377 and the IBC and IRC are outside the scope of this report.**
- Intumescent Coating (Exposed Face)** – International Fireproof Technology Inc. DC315 intumescent coating must be applied over the exposed surface of the spray foam insulation at a minimum 24 mils [0.024-inch (0.61 mm)] dry film thickness (DFT) on the fire exposed face of the wall assembly. Application must be in accordance with the manufacturer's published instructions.

FIGURE 8— NON-LOADBEARING WALL ASSEMBLY No. 5 CONSTRUCTION DETAILS

Assembly No.:	Assembly No. 6 (Asymmetrical)
Applicant:	INTERNATIONAL FIREPROOF TECHNOLOGY INC.
Product:	DC315 INTUMESCENT COATING
Code Section:	2024 IBC Section 705.8 (2021, 2018, 2015, 2012 and 2009 IBC Section 705.7)
Assembly Rating:	1-Hour from the Fire Exposed Face (Asymmetrical Wall Assembly) where protected openings are not limited by 2024 IBC Section 705.9 (2021, 2018, 2015, 2012 and 2009 IBC Section 705.8). 1-Hour from the Fire Exposed Face (Asymmetrical Wall Assembly) where protected openings are limited by 2024 IBC Section 705.9 (2021, 2018, 2015, 2012 and 2009 IBC Section 705.8) and correction is made to the area of protected openings in accordance with 2024 IBC Section 705.8 (2021, 2018, 2015, 2012 and 2009 IBC Section 705.7) using $F_{EO} = 0.01$, (Note: See Conditions of Use – Sections 5.5 and 5.6)
Load:	Non-loadbearing

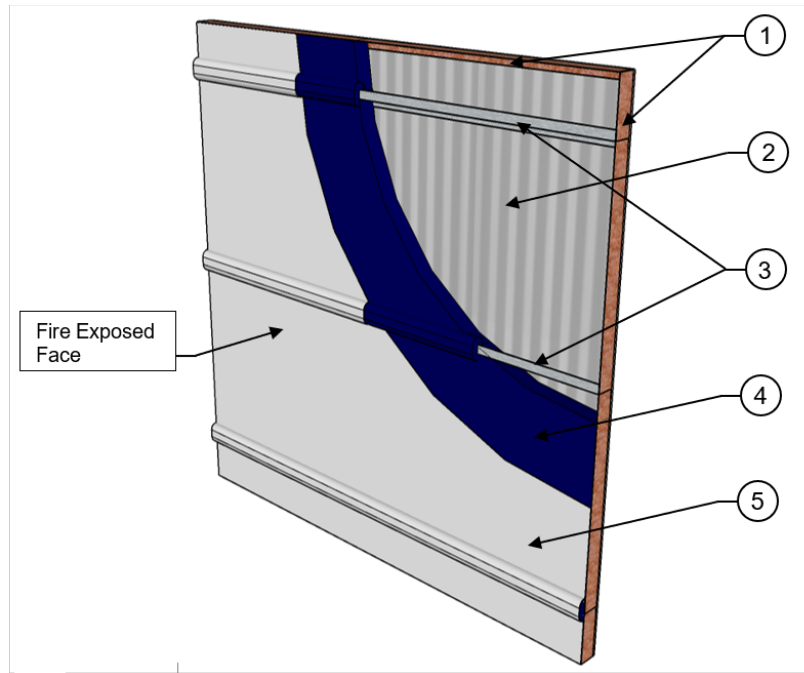

COMPONENTS OF CONSTRUCTION:

- Perimeter Framing Members** – Minimum 16-gauge thick steel members with minimum 4-inch by 2-inch (101.6 mm by 50.8 mm) legs are used as perimeter framing for the wall assembly. The perimeter framing members are oriented to allow for wall sheathing attachment and secured to each other using minimum two 1/2-inch (12.7 mm) long No. 8 pan head self-drilling screws at each corner.
- Wall Sheathing (Unexposed Face)** – Minimum 26-gauge thick and 36-inch (914.4 mm) wide commercial grade steel R-panels with 1 1/4-inch (31.8 mm) deep ribs must be installed vertically with panel seams overlapping in accordance with the manufacturer's published installation instructions. Panels must be secured to each other along the vertical overlapping seam using 1-inch (25.4 mm) long No. 12 external hex washer head self-drilling screws spaced at a maximum of 16-inches (406.4 mm) on center vertically. Panels are secured to the perimeter framing members using 1-inch (25.4 mm) long No. 12 external hex washer head self-drilling screws spaced at a maximum of 16-inches (406.4 mm) on center around the perimeter of the wall assembly. Panels must be secured to the intermediate support framing using 1 1/2-inch (38.1 mm) long No. 12-14 external hex washer head self-drilling screws spaced at a maximum of 12-inches (304.8 mm) on center horizontally along each intermediate support framing member.
- Intermediate Support Framing** – Intermediate wall framing members consist of minimum 16-gauge thick, 4-inch (101.6 mm) deep Z- or C-girts with 2-inch (50.8 mm) legs installed horizontally and spaced at a maximum of 48-inches (1219.2 mm) on center. The intermediate support framing members are secured to the perimeter framing members using minimum two 1/2-inch (12.7 mm) long No. 8 pan head self-drilling screws at each end.
- Insulation** – IPS Innovative Polymer Systems IPS 2000HFO spray-applied polyurethane foam (SPF) insulation, with a reported density of 2.18 lbs./ft³ (34.92 kg/m³), must be applied at a nominal thickness of 4-inches (101.6 mm) between the intermediate support framing members, applied directly to the fire exposed face of the wall sheathing. SPF insulation must also be applied to the intermediate support framing members at a nominal thickness of 1 1/2-inch (38.1 mm) matching the contour of the Z- or C-girts. Application must be in accordance with the manufacturer's published instructions. **Note: Evaluation of IPS Innovative Polymer Systems IPS 2000HFO SPF is limited to the ASTM E119 test data for the coated assembly described. Evaluation for compliance of the spray foam insulation with other applicable requirements of AC308 and the IBC and IRC are outside the scope of this report.**
- Intumescent Coating (Exposed Face)** – International Fireproof Technology Inc. DC315 intumescent coating must be applied over the exposed surface of the spray foam insulation at a minimum 24 mils [0.024-inch (0.61 mm)] dry film thickness (DFT) on the fire exposed face of the wall assembly. Application must be in accordance with the manufacturer's published instructions.

FIGURE 9— NON-LOADBEARING WALL ASSEMBLY No. 6 CONSTRUCTION DETAILS

Assembly No.:	Assembly No. 7 (Asymmetrical)
Applicant:	INTERNATIONAL FIREPROOF TECHNOLOGY INC.
Product:	DC315 INTUMESCENT COATING
Code Section:	2024 IBC Section 705.8 (2021, 2018, 2015, 2012 and 2009 IBC Section 705.7)
Assembly Rating:	1-Hour from the Fire Exposed Face (Asymmetrical Wall Assembly) where protected openings are not limited by 2024 IBC Section 705.9 (2021, 2018, 2015, 2012 and 2009 IBC Section 705.8). 1-Hour from the Fire Exposed Face (Asymmetrical Wall Assembly) where protected openings are limited by 2024 IBC Section 705.9 (2021, 2018, 2015, 2012 and 2009 IBC Section 705.8) and correction is made to the area of protected openings in accordance with 2024 IBC Section 705.8 (2021, 2018, 2015, 2012 and 2009 IBC Section 705.7) using $F_{EO} = 0.01$, (Note: See Conditions of Use – Sections 5.5 and 5.6)
Load:	Non-loadbearing

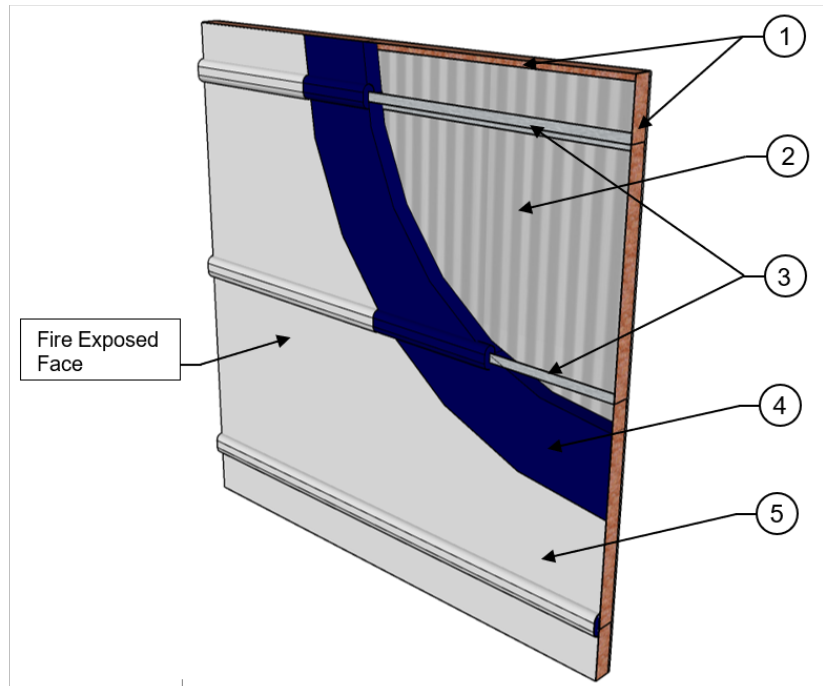

COMPONENTS OF CONSTRUCTION:

- Perimeter Framing Members** – Minimum 16-gauge thick steel members with minimum 4-inch by 2-inch (101.6 mm by 50.8 mm) legs are used as perimeter framing for the wall assembly. The perimeter framing members are oriented to allow for wall sheathing attachment and secured to each other using minimum two 1/2-inch (12.7 mm) long No. 8 pan head self-drilling screws at each corner.
- Wall Sheathing (Unexposed Face)** – Minimum 26-gauge thick and 36-inch (914.4 mm) wide commercial grade steel R-panels with 1 1/4-inch (31.8 mm) deep ribs must be installed vertically with panel seams overlapping in accordance with the manufacturer's published installation instructions. Panels must be secured to each other along the vertical overlapping seam using 1-inch (25.4 mm) long No. 12 external hex washer head self-drilling screws spaced at a maximum of 16-inches (406.4 mm) on center vertically. Panels are secured to the perimeter framing members using 1-inch (25.4 mm) long No. 12 external hex washer head self-drilling screws spaced at a maximum of 16-inches (406.4 mm) on center around the perimeter of the wall assembly. Panels must be secured to the intermediate support framing using 1 1/2-inch (38.1 mm) long No. 12-14 external hex washer head self-drilling screws spaced at a maximum of 12-inches (304.8 mm) on center horizontally along each intermediate support framing member.
- Intermediate Support Framing** – Intermediate wall framing members consist of minimum 16-gauge thick, 4-inch (101.6 mm) deep Z- or C-girts with 2-inch (50.8 mm) legs installed horizontally and spaced at a maximum of 48-inches (1219.2 mm) on center. The intermediate support framing members are secured to the perimeter framing members using minimum two 1/2-inch (12.7 mm) long No. 8 pan head self-drilling screws at each end.
- Insulation** – Dynamo Polyurethanes dynamo ECO 2000 spray-applied polyurethane foam (SPF) insulation, with a reported density of 2.18 lbs./ft³ (34.92 kg/m³), must be applied at a nominal thickness of 4-inches (101.6 mm) between the intermediate support framing members, applied directly to the fire exposed face of the wall sheathing. SPF insulation must also be applied to the intermediate support framing members at a nominal thickness of 1 1/2-inch (38.1 mm) matching the contour of the Z- or C-girts. Application must be in accordance with the manufacturer's published instructions. **Note: Evaluation of Dynamo Polyurethanes Dynamo ECO2000 SPF is limited to the ASTM E119 test data for the coated assembly described. Evaluation for compliance of the spray foam insulation with other applicable requirements of AC377 and the IBC and IRC are outside the scope of this report.**
- Intumescent Coating (Exposed Face)** – International Fireproof Technology Inc. DC315 intumescent coating must be applied over the exposed surface of the spray foam insulation at a minimum 24 mils [0.024-inch (0.61 mm)] dry film thickness (DFT) on the fire exposed face of the wall assembly. Application must be in accordance with the manufacturer's published instructions.

FIGURE 10— NON-LOADBEARING WALL ASSEMBLY No. 7 CONSTRUCTION DETAILS